



Ingeteam

INGECON SUN Power 100 U

Indoor

Installation Manual



AAS2000IKI04_
11/2012

Ingeteam Inc

3550 W. Canal St.
Milwaukee, WI 53208 - USA
Tel.: +1 (414) 934 4100
Fax.: +1 (414) 342 0736
e-mail: solar.us@ingetteam.com
Service Call Center: +1 (414) 934 4158



The copy, distribution or use of this document or of its content requires written authorisation. Any breach thereof will be reported for damages. All rights reserved including those of patent rights or design registration.

The conformity of the document content with the hardware described has been checked. However, discrepancies may exist. Liability will not be assumed for total concordance. The information contained in this document is regularly reviewed and it is possible that there may be changes in subsequent editions. Other functions may be available which are not covered by this document.

This document may be changed.

Important safety precautions

This manual contains important instructions for the installation, handling and use of the following models:

- INGECON SUN 100 U 208 Indoor.
- INGECON SUN 100 U 480 Indoor.

and any models derived from these.

Read these instructions carefully and keep them in a safe place.

General warnings



The operations described in the manual may be performed only by qualified personnel.

The status of qualified personnel referred to in this manual will be, as a minimum, that which meets all the standards, regulations and laws regarding safety applicable to the tasks of installing and operating this unit.

The responsibility for designating qualified personnel will always fall to the company to which the personnel belong. It is necessary to decide which workers are suitable or not for carrying out specific work to preserve their safety at the same time as complying with occupational safety legislation.

These companies are responsible for providing appropriate training in electrical equipment to their personnel and for familiarising them with the contents of this manual.



All applicable safety-related legislation for electrical work must be complied with. Danger of electric shock.

Compliance with the safety instructions set out in this manual or in the suggested legislation does not imply exemption from other specific standards for the installation, place, country or other circumstances that affect the inverter.



Opening the door of the housing does not imply there is no voltage inside.

The risk of electric shock exists even after disconnecting from the grid, the wind generator and the auxiliary supplies.

Only qualified personnel may open it, following the instructions in this manual.



The entire manual must be read and understood in full prior to manipulating, installing or operating the unit.



Category III - 1000-Volt measuring instruments must be used for checking for the absence of voltage.

Ingeteam accepts no liability for any damages caused by improper use of the equipment.



Carry out all control and handling without voltage.

As a minimum security measure in this operation, the so-called **five golden rules** should always be followed:

1. Disconnect
2. Prevent any possible resupply
3. Check there is no voltage
4. Ground and short circuit the equipment
5. Protect from live elements, if any, and put up safety signs around the work zone.

Until these five steps are completed, the work area cannot be considered voltage-free and any work performed will be considered to be work on live equipment.

Potential hazards for people

Bear in mind the following warnings concerning personal safety.



DANGER: Electric Shock.

The equipment may remain charged after disconnecting the PV array, mains power and auxiliary power.

Carefully follow the mandatory steps in the manual for removing the voltage.



DANGER: Explosion.

There is a very low risk of explosion in very specific cases of malfunction.

The casing will protect people and property from the explosion only if it is correctly closed.



DANGER: Crushing and joint injuries.

Always follow the indications in the manual on moving and placing the unit.

The weight of this unit can cause lesions, serious injury and even death if not handled correctly.



DANGER: High temperature.

The flow of air from the top outlet can reach high temperatures which can cause injury to people exposed.

Potential hazards for the equipment

Bear in mind the following warnings concerning protection of the equipment.



CAUTION: Ventilation.

The unit requires quality air flow while it is operating.

Keeping the unit in the upright position and the inlets free of obstacles is essential for this air flow to reach the inside.



CAUTION: Connections.

After all duly authorised handling, check that the equipment is ready to start operation. Only after this can it be connected following the instructions in the manual.



Do not touch boards or electronic components. The most sensitive components can be damaged or destroyed by static electricity.



Do not disconnect or connect any terminal while the unit is operating. Disconnect and check for absence of voltage first.

Personal protection equipment (PPE)

Use all items comprising the protection equipment.

Chapter "4. Safety instructions" contains references to the use of this equipment depending on the situation.



The standard personal protective equipment is:

- Safety goggles for mechanical hazards.
- Safety goggles for electrical hazards.
- Safety footwear.
- Helmet.

Cabling and torque requirements

Model	Wiring	Material	Section	Tightening torque St.st. bolts (unlubricated)		
				5/16" (M8)	3/8" (M10)	7/16" (M12)
INGECON SUN 100 U 208						
Input terminals (DC)						
Minimum	1/0AWG 194 °F (90 °C)	Copper	0.09 in ² (53.5 mm ²)			650 lb.in (73.4 Nm)
		3/0AWG 194 °F (90 °C)	Aluminum			
Maximum	4/0 AWG 194 °F (90 °C)	Copper	0.17 in ² (107.2 mm ²)			
	4/0 AWG 194 °F (90 °C)	Aluminum	0.17 in ² (107.2 mm ²)			
Output terminals (AC)						
Minimum	2/0 AWG 194 °F (90 °C)	Copper	0.11 in ² (67.5 mm ²)		385 lb.in (43.5 Nm)	
		4/0 AWG 194 °F (90 °C)	Aluminum			
Maximum	4/0 AWG 194 °F (90 °C)	Copper	0.17 in ² (107.2 mm ²)			
	4/0 AWG 194 °F (90 °C)	Aluminum	0.17 in ² (107.2 mm ²)			
INGECON SUN 100 U 480						
Input terminals (DC)						
Minimum	1/0AWG 194 °F (90 °C)	Copper	0.09 in ² (53.5 mm ²)			650 lb.in (73.4 Nm)
		3/0AWG 194 °F (90 °C)	Aluminum			
Maximum	4/0 AWG 194 °F (90 °C)	Copper	0.17 in ² (107.2 mm ²)			
	4/0 AWG 194 °F (90 °C)	Aluminum	0.17 in ² (107.2 mm ²)			
Output terminals (AC)						
Minimum	1/0AWG 194 °F (90 °C)	Copper	0.09 in ² (53.5 mm ²)	216 lb.in (24.5 Nm)	385 lb.in (43.5 Nm)	
		3/AWG 194 °F (90 °C)	Aluminum			
Maximum	4/0 AWG 194 °F (90 °C)	Copper	0.17 in ² (107.2 mm ²)			
	4/0 AWG 194 °F (90 °C)	Aluminum	0.17 in ² (107.2 mm ²)			

Cabling must comply with the following codes:

- *National Electrical Code ANSI/NFPA 70.*
- *Canadian Electrical Code CEC.*
- Other local or state codes if applicable.

Spares









Reference	Quantity	INGECON SUN 100 U 208	INGECON SUN 100 U 208
CC1	1	EMI filter 400 A FS24875-360-99 Rev 0	EMI 180 A filter
AAS0026	1	Hw switching harmonic filter for 60 to 100 kW units	
AAS0049	1	DC intake protection	
QDC	1	Isolating switch with fuses	
F1, F2	2	UR type fuses 500 A, 600 VDC	
F6, F7, F8	3	50A fuses for arrestors	
IQ1	1	Contact OF-SD-SDE for Square D // ABB Aux 24 VDC	
Q1	1	Thermomagnetic protection Square DJL36400E20 // ABB TMAX T5N400 UL/CSA	Thermomagnetic protection Square D JJI36175 // ABB TMAX T3S 175 UL/CSA
Q1.M	1	Rotating door control: 32598 & S33875 & 32603 // ABB RHE T4-T5 NORM	Rotating door control: MG29338 // ABB RHET1-T2-T3-NORM
IQ3, IQ4, IQ5	3	Signage for motor protection GV2-P GVAE11	Signage for motor protection GV2-P GVAE11/ ABB HKF1-11
Q3	1	MCB 24 to 32 A Telemecanique GV2-P32	
Q4	1	MCB 0.1..0.16 A Telemecanique GV2-P01	MCB 0.1..0.16 A Telemecanique GV2-P01 /ABB MS 116-0.63
Q5	1	MCB 4..6.3 A Telemecanique GV2-P14	MCB 4..6.3 A Telemecanique GV2-P14 /ABB MS 116-6.3
K1	1	3-phase contactor 150 A Telemecanique LC1 F400 // ABB A260-30-10-80 ⁽¹⁾	3-phase contactor 150 A Telemecanique LC1 D150 // ABB A145-30-10-36 ⁽¹⁾
K1.A ⁽¹⁾	1	Coil 230 V for K1 Telemecanique LX1 P7 230	Coil 230 V for K1 Telemecanique LX1 D8U7 230
K1.AUX ⁽¹⁾	1	Auxiliary contact K1 (Telemecanique LA1DN11)	
K1.F	1	RC filter for K1 (Telemecanique LA4FRCP) // ABB RC5 - 2/250	RC filter for K1 (Telemecanique LA4DAZU) // ABB RC52/250
RVDC	2	DC arrestor for 600 V UL	
RVAC	4	120 VAC arrestors	480 VAC arrestors
SW2.NC	1	Auxiliary NC contact for the emergency stop button.	
C2, C3	2	Condensers for EBM axial fans 4 µF	
C1	1	Condensers for EBM centrifugal fans 4 µF	
AAS0091	1	Matrix hardware display, keyboard, LEDs, CAN, etc.	
AAS7131	1	Power block for INGECON SUN 100 U equipment	



⁽¹⁾ If reference K1 is fitted with an ABB A260-30-10-803-phase contactor, it will not be necessary to equip references K1.A and K1.AUX, since the contactor itself has the required 230 V coil and auxiliary contact. On the other hand, if the reference K1 is fitted with the Telemecanique LC1 F400 contactor, it will be necessary to include the components shown for references K1.A and K1. AUX.



Contact the Ingeteam telephone customer assistance with any questions.

Symbols on the inverters

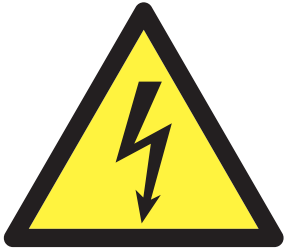

Warning symbols on the inverter are as follows:

	Connection from cable and phase 1 terminal.
	Connection from cable and phase 2 terminal.
	Connection from cable and phase 3 terminal.
	DC outlet.
	AC outlet.
	Ground terminal
	Grounded points
	On
	Off

	 WARNING
	For Continued Protection Against Risk Of Fire Replace Only With Same Fuse Type And Rating.

	 WARNING
	RISK OF ELECTRIC SHOCK. Normally grounded conductors may be ungrounded and energized when a ground-fault is indicated.

	 WARNING
	<p>RISK OF ELECTRIC SHOCK DO NOT REMOVE COVER.</p> <p>No user serviceable parts inside. Refer servicing to qualified service personnel.</p>

	 WARNING
	<p>RISK OF ELECTRIC SHOCK FROM ENERGY STORED IN CAPACITOR.</p> <p>Do not remove cover until 5 minutes after disconnecting all sources of supply.</p>

	 WARNING
	<p>FOR CONTINUED PROTECTION AGAINST RISK OF FIRE.</p> <p>Replace only with same fuse type and rating.</p>

	 WARNING
	<p>HOT SURFACES.</p> <p>To reduce the risk of burns do not touch.</p>

Table of Contents

1. Overview	13
1.1. Equipment description	13
1.1.1. Models	13
1.2. Configuration parameters	14
1.3. Compliance with regulations	15
2. System description	15
2.1. Location	15
2.1.1. Environment.....	15
2.1.2. Protection class.....	15
2.1.3. Ambient temperature.....	16
2.1.4. Atmospheric conditions.....	16
2.1.5. Contamination class	16
2.1.6. Acoustic contamination.....	16
2.1.7. Ventilation.....	16
2.1.8. Environmental characteristics	17
2.2. Characteristics of the electrical installation	17
2.3. EMC requirements.....	17
3. Operating, storage and transport conditions	18
3.1. Symbols	18
3.2. Equipment reception	18
3.3. Handling and unpacking	19
3.4. Moving the equipment	20
3.5. Storage	21
3.6. Conservation.....	21
3.7. Waste handling.....	21
4. Safety instructions	23
4.1. Symbols	23
4.2. General safety precautions	23
4.3. General	24
4.3.1. General risks existing and preventive measures.....	25
4.3.2. Additional risks and measures in handling tasks	25
4.4. Type of tasks to be carried out.....	25
4.4.1. Inspection tasks.....	25
4.4.2. Handling tasks.....	25
4.4.3. Personal protection equipment (PPE)	26
4.5. Safety measures while working	26
5. Installation	28
5.1. General requirements for installation	28
5.2. Fixing the unit to the floor	28
5.3. Insulation monitor	31
5.4. Electrical connection	31
5.4.1. Description of cable inlets.....	32
5.4.2. Description of cabling connections.....	33
5.4.3. Order of connecting the unit.....	33
5.4.4. System wiring diagram.....	33
5.4.5. Insulation fault contact / grid connection indicator.....	34
5.4.6. Access to auxiliary connections.....	34
5.4.7. Connection for communication via RS-485 serial port.....	35
5.4.8. Connection for communication via modem-GSM/GPRS + RS-485.....	35
5.4.9. Connection for Ethernet communication	36
5.4.10. Ground connections.....	37
5.4.11. Grid connection.....	37
5.4.12. Connecting to the PV array	38
5.5. Grounding	39
6. Commissioning	42
6.1. Equipment inspection	42
6.1.1. Inspection.....	42

- 6.1.2. Shutting down.....42
- 6.2. Start-up43
 - 6.2.1. Start-up43
 - 6.2.2. Checking and measurement43
- 7. Preventive maintenance..... 44
 - 7.1. Maintenance tasks 44
- 8. Display control46
 - 8.1. Keypad and LEDs.....46
 - 8.2. Display.....47
 - 8.3. Main menu 48
 - 8.4. Monitoring..... 48
 - 8.5. Reasons for shutdown.....50
 - 8.6. Settings51
 - 8.6.1. Date and Time51
 - 8.6.2. Inverter number change51
 - 8.6.3. Language51
 - 8.6.4. Grid quality51
 - 8.6.5. Ground connection.....51
 - 8.6.6. Connection time.....52
 - 8.6.7. Total reset52
 - 8.6.8. Other adjustments52
 - 8.6.9. Change NumCAN52
 - 8.7. Inverter data52
 - 8.8. Change inverter number.....52
- 9. Troubleshooting.....53
 - 9.1. LED messages53
 - 9.1.1. Green LED.....53
 - Slow flashing53
 - Fast flashing53
 - Steady light53
 - 9.1.2. Orange LED54
 - Fast flashing54
 - 9.1.3. Red LED.....54
 - Steady light54
 - 9.2. List of alarms and reasons for shutdown55
 - 9.3. Inverter alarms due to protections56
 - 9.4. Action protocol for responding to incidents.....57
 - 9.4.1. Voltage and/or frequency out of range57
 - 9.4.2. Temperature59
 - 9.4.3. AC circuit protection.....60
 - 9.4.4. Reason for contactor shutdown61
 - 9.4.5. DC circuit protections61
 - 9.4.6. Insulation fault.....61
 - 9.4.7. Manual shutdown63
 - 9.4.8. Protection of the switching filter63
 - 9.5. Replacing the electronics block.....63
 - 9.6. Replacing varistors in the intake board65
 - 9.7. Description of terminal strips66

1. Overview

The purpose of this manual is to describe the INGECON SUN 100 U unit and to give appropriate information for its correct receipt, installation, start-up, operation and maintenance.

1.1. Equipment description

An inverter is a circuit used to convert direct current to alternating current. The function of the INGECON SUN 100 U units is to convert the direct current generated by photovoltaic solar panels to alternating current and so enable it to be fed to the electricity grid.

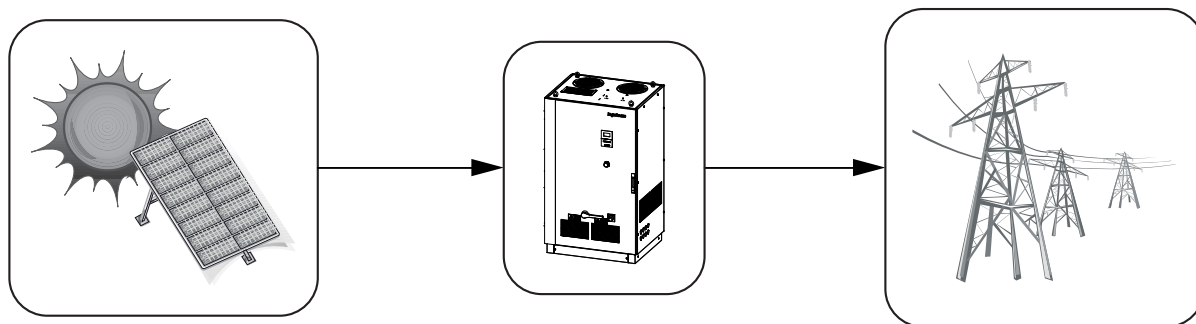

1.1.1. Models

The INGECON SUN 100 U product family is split into two models, both of which have transformers:

- INGECON SUN 100 U 208 Indoor
- INGECON SUN 100 U 480 Indoor

The various output voltages are as follows:

Model	AC output voltage
INGECON SUN 100 U 208 Indoor	AC output 3X208 V
INGECON SUN 100 U 480 Indoor	AC output 3X480 V

Both units have a similar outward appearance:

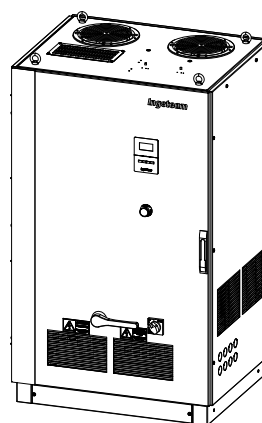

1.2. Configuration parameters

DC input

	INGECON SUN 100 U 208	INGECON SUN 100 U 480
Range of input operating voltage	300 ~ 600 V	
Maximum input voltage	600 V	
Maximum input current	350 A	
Maximum input short circuit current	600 A	
Maximum input source backfeed current to input source	0 A	0 A

AC output

	INGECON SUN 100 U 208	INGECON SUN 100 U 480
Output power factor rating	>0.99	
Operating voltage range (AC) (L-L)1	183 ~ 229 V	422.5 ~ 528 V
Operating frequency range or single frequency ¹	57 ~ 60.5 Hz	
Number of phases	3	
Nominal output voltage (AC)	208 Vac	480 Vac
Normal output frequency	60 Hz	
Maximum continuous output current (AC) per line	277.8 A	120.3 A
Rated power (AC)	100 kW	100 kW
Maximum output fault current (AC) and duration	2060 A at 8.8 ms	410 A at 6.67 ms
Maximum output overcurrent protection	400 A	156 A
Normal operating temperature range	-4 °F (-20 °C) ~ 149 °F (65 °C)	
Maximum full power operating ambient	113 °F (45 °C)	
Enclosure Rating Type	NEMA type 1 (IP20)	

Utility interconnection voltage and frequency trip limits and trip times:			
Condition	Simulated utility source		Maximum time (in seconds) at 60 Hz before current is cut off to the simulated utility
	Voltage (V)	Frequency (Hz)	
A	< 0.50 V _{nor}	Rated	0.16
B	0.50 V _{nor} ≤ V < 0.88 V _{nor} (Adjustable Set Points)	Rated	0.16 ~ 2.667 (Adjustable Set Points)
C	1.01 V _{nor} < V < 1.11 V _{nor} (Adjustable Set Points)	Rated	0.16 ~ 2 (Adjustable Set Points)
D	1.20 V _{nor} ≤ V	Rated	0.16
E	Rated	f > 60.5	0.16
F	Rated	f < (59.8 ~ 57.0) (Adjustable Set Points)	0.16 ~ 300
G	Rated	f < 57	0.16

Precision of values and disconnection time of the voltage and frequency protections.	
Voltage	± 1 %
Frequency	± 0.1 Hz
Time	0.06 s

1.3. Compliance with regulations

UL 1741

UL Standard for Safety for Inverters, Converters, Controllers and Interconnection System Equipment for Use With Distributed Energy Resources, Second Edition, Dated January 28, 2010.

CSA

CAN/CSA-C22.2 No. 0-M91 - General Requirements - Canadian Electrical Code - Part II.

0.4-04 - Bonding of Electrical Equipment.

107.1-01 - General Use Power Supplies.

IEEE 1547.1_{TM}

IEEE Standard Conformance Test Procedures for Equipment Interconnecting Distributed Resources with Electric Power Systems.

2. System description

2.1. Location

INGECON SUN 100 U units need to be installed in environments with specific characteristics.

Guidelines are provided in this section for choosing a suitable environment and adapting the unit to it properly.

2.1.1. Environment



Place the units in a place which is accessible for installation and maintenance work and which permits use of the keyboard, the display and the reading of the front indicator LEDs.



The air vents and part of the cabinet close to them can reach 185 °F (85 °C). Do not place any material nearby which is sensitive high air temperatures.



Avoid corrosive environments that may affect the proper operation of the inverter.



Never place any object on top of the unit.

2.1.2. Protection class

INGECON SUN 100 U units have a NEMA type 1 level of protection against external agents.

INGECON SUN 100 U units should therefore be installed in an enclosed, covered location.

The environment in which they are assembled should always be dry and free of dust.

Not suitable for outdoor installation.

2.1.3. Ambient temperature

These units are designed to operate in a temperature range from -4 °F (-20 °C) to 149 °F (65 °C). Nominal power may be input at up to 113 °F (45 °C). Above this temperature the unit limits input power in order to cool the internal temperature of the electronics.

2.1.4. Atmospheric conditions

The ambient air must be clean and relative humidity must not exceed 50% at over 104 °F (40 °C). Higher levels of relative humidity, up to 95%, can be tolerated at below 86 °F (30 °C).

It should be borne in mind that moderate condensation may occasionally occur as a consequence of temperature variations. For this reason, apart from the unit's own protection, vigilance of these units is necessary once they have been started up on sites where the conditions described above are not expected to be present.

In the event of condensation, never apply voltage to the unit.

2.1.5. Contamination class

The pollution class for which the units have been designed is grade 3.

Suitable measures should be taken to provide dust-free air of sufficient quality in the vicinity of the inverter.

2.1.6. Acoustic contamination

When on, the inverter generates a buzzing sound.

Do not place it in an occupied room, or on light supports which might amplify this buzz. The mounting surface must be firm and appropriate for the weight of the unit.

2.1.7. Ventilation

A minimum space of 8 in (20 cm) must be maintained on both sides and in front of the unit to allow the free circulation of air through the circulation vents.



INGECON SUN 100 U units are fitted with cooling fans on top of each cabinet. These fans start up for a few seconds each time the inverter is connected to the mains and is about to inject power. This procedure makes it possible to easily check proper operation.

The fans require an adequate flow of clean, dust-free air for proper operation. The required flow is 58.86 ft³/s (6000 m³/h) for all models.

When the unit is installed inside a room a pressure loss of up to 34 Pa is acceptable in the fan circuit and the air must be no greater than 9.8 ft/s (3 m/s).



Do not place any object on top of the unit.
Avoid dropping particles that could enter the unit through air vents.



Facilitate the flow of air entering through the front and side ventilation grids, and the exhaust air through the top grids.

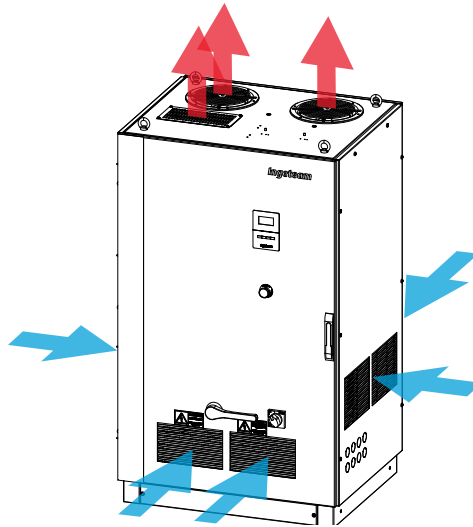

2.1.8. Environmental characteristics

The environmental conditions for operation are:

Ambient conditions	
Minimum temperature	-4 °F (-20 °C)
Minimum surrounding air temperature	-4 °F (-20 °C)
Minimum surrounding air temperature	149 °F (65 °C)
Temperature at which power limiting commences	113 °F (45 °C)
Maximum relative humidity without condensation	95%

For further information see Chapter “3. Operating, storage and transport conditions”.

2.2. Characteristics of the electrical installation

INGECON SUN 100 U units are designed to be connected to the public low voltage grid.

2.3. EMC requirements

The INGECON SUN 100 U units are equipped with the necessary filtering elements to comply with EMC requirements for industrial applications in order to prevent disturbances in other equipment outside the installation.

3. Operating, storage and transport conditions



Failure to follow the instructions provided in this section may lead to damage to the equipment. Ingeteam accepts no liability for damage resulting from the failure to follow these instructions.

3.1. Symbols

Bear in mind the following symbols:



Move transport packaging with this side up



Do not use sharp tools to open the shipping packaging



Prevent the unit from becoming wet.



Do not place anything on top of the shipping packaging



The contents of the shipping container are fragile

3.2. Equipment reception

Reception

Upon receipt of the shipment, check the terms specified in the *Delivery Note*, sign the *Signature Receiver Goods* field and return the copy to the return address.

Keep the unit in its packaging until immediately before installation. Maintain the unit **upright** at all times.



The features of the INGECON SUN 100 U upon reception are as follows:

Model	Packing pallet	Weight	Length x Depth x Height
INGECON SUN 100 U 208	Bubble wrap and plastic bag on wooden pallet	3968.32 lb (1800 Kg)	74.8 in x 43.7 x 35.43 in (1900 x 1110 x 900 mm)
INGECON SUN 100 U 480			

Identifying the unit

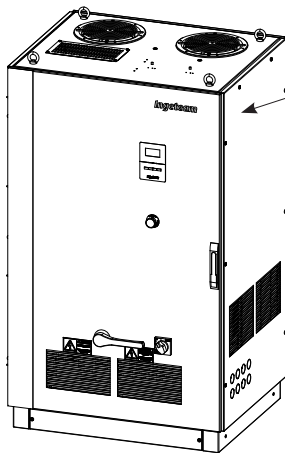
The serial number of the equipment is its unique identifier. This number must be quoted in any communication with Ingeteam.



 		Ingeteam INC. 5201 Great American Parkway, Suite 320 SANTA CLARA, CA 95054 - USA Tel.: +1 (415) 450 1869 +1 (415) 450 1870 Fax.: +1 (408) 824 1327 e-mail: solar.us@ingeteam.com	
Master Project: 2143022 File Number: 243647			
Model/ Type	INGECON SUN 100 U 280	Date of Manufacture	2011/09
Rated 100 U	100 kW	Normal operating temperature range	-4 °F (-20 °C) ~ 149 °F (65 °C)
Voltage (AC)	208 V (183 ~ 229 V) ± 1% 0.06 s	Type of enclosure	1
Frequency	60 Hz (57 Hz ~ 60.5 Hz) ± 1 Hz 0.06 s	Range of input operating voltage	300 ~ 600 V
Output 100 U Factor Rating	0.99 < Cos φ < 1	Max. input short circuit current	600 A
Max. output fault current (AC) and duration	2060 A at 8.8 ms	Max. input source backfeed current to input source	0 A
Max. output overcurrent protection	400 A		
Serial Number	XXXXXXXXXX		

Location of the name plate inside the unit

There is another ratings plate in a visible internal location.

Transport damage

If the equipment has been damaged during transport, proceed as follows:

1. Do not proceed with the installation.
2. Notify the distributor immediately within 5 days of receipt of the equipment.

If ultimately the unit has to be returned to the manufacturer, you must use the same original packaging.

3.3. Handling and unpacking

Correct handling of the units is vitally important in order to:

- Prevent damage to the packaging which enables them to be kept in optimum condition from shipping until they are unpacked.
- Avoid knocks and/or falls which may harm their mechanical characteristics, e.g. cause incorrect closure of doors, loss of IP rating, etc.
- Avoid, as far as possible, vibrations which may cause subsequent malfunction.

If you observe any anomaly, please contact Ingeteam immediately.

Separating the packaging

All the packaging can be delivered to a non-hazardous waste management company.

In any event, each part of the packaging may be recycled as follows:

- Plastic (polystyrene, bag and bubble wrap): the appropriate container.
- Cardboard: the appropriate container.

3.4. Moving the equipment

Appropriate transport and storage of the unit are the necessary first steps for correct use and operation. Taking the above section into account and as a preventive measure, Ingeteam recommends the use of transport companies specialised in the transport of special and/or fragile equipment.

The unit must be protected, during transport and storage, from mechanical knocks, vibrations, water splashes (rain) and any other product or situation which may damage it or alter its behaviour.

Failure to observe these instructions may lead to loss of warranty on the product, for which Ingeteam is not responsible.

When transporting INGECON SUN 100 U units it is essential to maintain the unit in the upright position, even if it is being returned to the factory.

If the equipment has to be moved, be aware that the centre of gravity of these units is at the centre of its vertical projection and at 1/3 of its height.

Transport using goods vehicles

During transport, INGECON SUN 100 U units must be kept in an upright position and properly secured in accordance with their weight and size to avoid tipping and bumps.

Transport using a forklift truck

At least the following requirements should be observed:

1. Place the packaged unit centred with respect to the forks.
2. Try to locate it as close as possible to the connection between the forks and the chassis.
3. Ensure that the forks are perfectly level to avoid overturning the unit.
4. In any case, observe the instructions in the forklift truck's user manual.
5. If it is transported after having been unpacked, unscrew the base being moving it.

Transport using a crane

When lifting by crane, the lifting eyes fitted to the top corners of the cabinet should be used, as shown below.

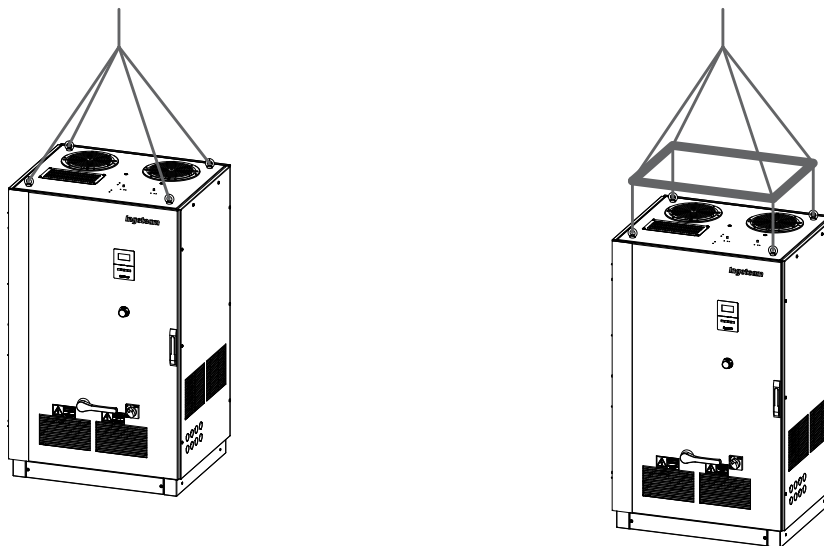

Ensure that the load is distributed evenly between the eyes by fixing individual cables, chains or ropes to each of the eyebolts, taking into account that the angle formed by each pair of cables on the same side is less than or equal to 45° and ensuring that the cables are as vertical as possible.

It is always advisable to use a load frame as in the adjoining figure for a proper distribution of the loads, bearing in mind that the angle ϕ should be equal to 90°.

3.5. Storage

If the unit is not installed immediately after receipt, the following points should be taken into account in order to prevent damage:

- The package must be stored in the vertical position.
- Keep the unit free of dirt (dust, shavings, grease, etc) and away from rodents.
- Keep away from water splashes, welding sparks, etc.
- Cover the unit with a breathable protective material in order to prevent condensation due to ambient humidity.
- Units in storage must not be subjected to climate conditions other than those indicated in Section “2.1.8. Environmental characteristics”.
- It is very important to protect the unit from chemical products which can cause corrosion, as well as from salty atmospheres.
- Do not store the unit outdoors.

3.6. Conservation

In order to permit correct conservation of the units, they must not be removed from their original packaging until it is time to install them.

In case of prolonged storage, the use of dry places avoiding, as far as possible, sharp changes in temperature is recommended.

Deterioration of the packaging (tears, holes, etc.) prevents the units from being kept in optimum conditions before installation. Ingeteam accepts no liability in the case of failing to observe this condition.

3.7. Waste handling

During the various processes for installation, start-up and maintenance, waste is generated which must be handled appropriately according to the regulations in the corresponding country.

At the end of the unit's life, the waste must be processed by an authorised waste management company.

Ingeteam, in accordance with its policy of respect for the environment, will inform the authorised manager, via this Section, of the location of components to be decontaminated.

The elements within the unit that must be handled individually are:

1. Liquid crystal displays.
2. Printed circuit cards.

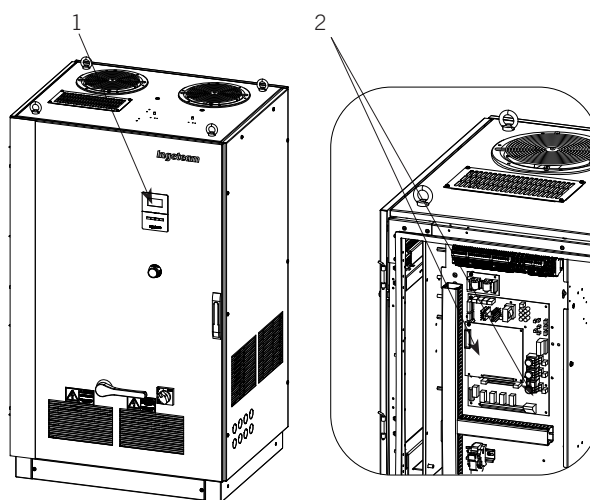

Current environmental legislation and any client requirements must be complied with in all actions performed. Close attention should be paid to the handling of hazardous materials and proper waste separation.

Waste that can be handled by conventional waste collection means

Most of this waste is from the unit's packaging, which must be properly separated and processed.

All the packaging can be delivered to a non-hazardous waste management company.

In any event, each part of the packaging may be recycled as follows:

- Plastic (polystyrene, bag and bubble wrap): Appropriate container (plastic and bottles).
- Cardboard: Appropriate container (paper and cardboard).

4. Safety instructions

This section contains safety instructions which must be followed when installing, operating and accessing the unit.

Failure to comply with the “Safety instructions” may cause injury or even death or cause damage to the unit.

Read the “Safety instructions” carefully before working on the unit.

4.1. Symbols

The warnings advise of conditions which may cause serious injury or death and/or damage to the equipment. The means of avoiding the hazard to both people and the unit is indicated along with the warning.

The symbols and an explanation of their meaning can be seen below.



DANGER: High voltage

High voltage warning: Warns of high voltage which can cause injury or even death and/or damage to the equipment.



General warning. Warns of conditions which can cause injury and/or damage to the equipment.



PRECAUTION: Hot surface

Warns of the existence of hot parts which may cause serious burns.

The specific safety warnings and notes which affect specific tasks are included in each affected chapter and are repeated and completed within each chapter in the corresponding critical points.

Please read this information carefully as it is written for your personal safety and to ensure the longest possible service life for the unit and the devices to which it is connected.

4.2. General safety precautions



Installation, start-up, inspection and maintenance operations may only be carried out by personnel appropriately qualified and trained in electrical subjects (hereinafter qualified personnel). You are reminded of the obligation to comply with safety regulations applicable to electrical work.



The fact that the various compartment housings are open in no way implies the absence of voltage. Only qualified personnel following the safety guidelines described in this document may access the compartments.



The set of conditions listed below should be considered as minimum requirements. It is always preferable to shut off the main power supply. Installation defects may result in unwanted feedback. Danger of electric shock.



In addition to the safety measures indicated in this manual, the general measures that apply in this area (specific to the installation, country, etc.) must be taken into account.



The electrical installation must not involve a risk of fire or explosion. Workers must be duly protected against accident risks from direct or indirect contact. The electrical installation and protection devices must take the voltage, the external determining factors and the competence of the people who have access to parts of the installation into account.



In compliance with basic safety legislation, all equipment must be appropriate to protect exposed workers against the risk of direct or indirect contacts. In any case, the electrical parts of the work equipment must comply with that laid down in the corresponding specific regulations.



In compliance with Electric Risk basic legislation, all workers who carry out work outdoors will suspend their work in the case of storms, rain or strong winds, snow or any other unfavourable environmental condition which makes visibility or handling tools difficult. Work on installations directly connected to overhead electricity lines must be interrupted in the case of storms.



Ingeteam accepts no liability for any damages caused by improper use of the equipment. Any work carried out on any equipment which implies a modification of the original electrical arrangements must be proposed in advance to Ingeteam. These must be studied and approved by Ingeteam.



The necessary means must be arranged to prevent people from outside the installation approaching or handling the equipment.



These instructions must be easily accessible close to the unit and located within reach of all users. Before installation and start-up, please read these safety instructions and warnings carefully as well as all the notices located on the unit. Ensure that all the notices are perfectly legible and that those which are damaged or have disappeared are restored.

4.3. General

This section defines the preventive measures to take to carry out all types of tasks on the unit, working safely and controlling risks which cannot be avoided.

Protection against direct contact is by means of the housing, which has NEMA Type 1 (IP20) protection class.

There are additional protections on the feeds, which must be removed in order to connect the unit but refitted before the supplies are powered up.

The unit has been tested according to the applicable regulations to comply with the safety requirements, the values for insulation distances and leakage paths for the voltages used.

The tools and/or equipment used in handling tasks must as a minimum have double reinforced insulation (Class II).

4.3.1. General risks existing and preventive measures

Impact against immovable objects

- Inform workers of the risk
- Adequate lighting
- Work with care
- Keep sufficient distance to prevent contact with the part causing the risk (control rod in the isolating switch door).

Knocks, punctures and cuts from objects and/or tools

- Keep the door closed unless working inside
- Adequate lighting
- Order and cleanliness
- Mandatory use of hard hat, safety footwear and gloves when necessary.

Flying particles (fan)

Recommended use of anti-impact glasses when accessing the fan area.

Electrical risk

- Follow the instructions in the section on PPE and “4.2. General safety precautions” en la página 23
- Inform the worker of the risk
- Comply with applicable regulation and legislation.

4.3.2. Additional risks and measures in handling tasks

Thermal contact

- Inform workers of the risk
- Recommended use of gloves
- Disconnect the power and wait 10 minutes for the hot parts inside the unit (R1, RAD1) to cool.

4.4. Type of tasks to be carried out

The preventive maintenance tasks for the electrical panels involve Inspection, Control and Handling actions, depending on the case.

Accessing the housing through any access point other than that described in this manual is strictly prohibited.

To open any of the covers of the enclosure (side, rear, top or door) the main power supply outside of the box must be switched off.

4.4.1. Inspection tasks

Definition: Involves opening the enclosure for visual inspection tasks.

4.4.2. Handling tasks

Definition: Tasks involving the assembly and/or replacement of parts as well as changes to the setting of panel components. Any task that does not fall under Inspection or Control is considered Handling.



It is always necessary to first disconnect and check for absence of voltage.
The “5 Golden Rules” must be adhered to.



5 GOLDEN RULES

1. Disconnect

Switching on the possible voltage sources. Bear in mind that any capacitors or other elements powered from uninterruptible power supplies (UPS) are still live.

2. Prevent any possible feedback.

The switching devices used to switch off the equipment must be protected against any possible reconnection.

3. Check there is no voltage.

Check that there is no voltage in all the active elements of the electrical system or as close as possible to the work area.

4. Ground and short circuit.

In the low voltage installations that by induction or for other reasons may be accidentally live. And always in high voltage installations.

5. Rope off and mark the work area.

4.4.3. Personal protection equipment (PPE)

Inspection

The use of safety footwear to standard EN 345-1:1992 is mandatory and work clothing should be cotton and be free of conductor/metallic elements.

Handling

The use of helmets compliant with standard *EN 397:1995* and safety footwear compliant with standard *EN 345-1:1992* is mandatory.

It is also mandatory to use dielectric gloves meeting standard *EN-60903-1992* and protective face mask against electric shock for voltage testing tasks and opening or closing automatic switches under load (IP2x).

4.5. Safety measures while working



It is strictly forbidden to gain access to the inside of the electrical panel through any other point than the front access door provided for the purpose. Opening any of the enclosure covers and/or accessing them (from the side, rear or top) triggers a general shutdown of all power to the panel (PV array, 3-phase feed and auxiliary single-phase feed, if any). Always access when the unit is voltage-free.



Any work carried out which implies a modification of the original electrical settings must be proposed to and accepted by Ingeteam.

Below are the obligatory safety standards and the various tasks that may be performed on the unit.

Opening system: the door is opened and closed by a handle with a double-bit lock. Mechanically interlocked door via controls in the isolating switch door.

Inspection: The protective elements (methacrylates) of the terminals and connection strips should be properly positioned at all times (avoid direct access to live parts).

Handling

To carry out handling on the unit, the voltage must be disconnected.

The following points must be taken into account to disconnect the unit from the power supply:

1. Stop the inverter from the display by switching status to stop or by using the emergency stop button located on the door.
2. Open the DC circuit breaker (PV array). (*)

3. Open the automatic AC switch (*).
4. Isolate the PV array powering the unit, from outside the panel. (**)
5. Switch off three-phase protection from the corresponding protection outside the units.
6. Wait 10 minutes for the internal capacitances to discharge (harmonic filter, etc.), for the existing internal resistors to cool and the fan blades to stop turning.
7. Check that there is no voltage by using an appropriate multimeter. This measurement is made at terminal strips XDC and X5. See Section “9.7. Description of terminal strips”. Use the PPE shown in section “4. Safety instructions”.
8. Signal cut-off points (DC/AC) with a sign indicating the type.

(*) When the DC circuit breakers and the automatic AC switches are switched to the OFF position (no voltage) a consignment lock will be placed on the door knobs (mechanical lockdown) and a sign reading “Do not touch. Personnel at work” will be posted.

(**) If the PV array cannot be isolated from outside the panel, bear in mind that the feeds to the CD circuit breakers will be live and work must be carried out using the appropriate PPE (dielectric gloves suitable for the working voltage, face shield, safety boots, working clothes, recommended fireproof clothes, etc.).

Any work carried out which implies a modification of the original electrical settings must be proposed to and accepted by Ingeteam.

5. Installation

Before installing the INGECON SUN 100 U unit, the packaging must be removed, taking special care not to damage the housing.

Check that there is no moisture inside the packaging. If there are signs of moisture, the unit must not be installed until you are sure it is completely dry.



All installation operations must comply with current regulations.

5.1. General requirements for installation

Ventilation and the space for work, which must be suitable for maintenance tasks according to current regulations.

The external connection devices, which must be suitable and sufficiently close as set forth in current regulations.

The connecting cables must be of the appropriate section for the maximum current.

Special care must be taken to ensure that there are no external elements near the air inlets and outlets to obstruct proper ventilation of the unit.

5.2. Fixing the unit to the floor

INGECON SUN 100 U units have an optional fixing system.

The system comprises a few metal plates that bolt the four corners of the base to the concrete pad where the inverter sits.

The figure below shows the shape of these strips and how they bolt onto the housing.

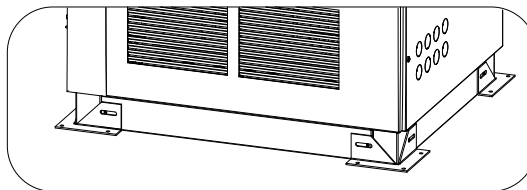

In order to avoid fixing problems, the base on which the inverter is fitted must be properly levelled.



In order to keep the nuts and bolts of the equipment in a proper condition, it is important while tightening them to make sure there is no dirt or shavings on the threads and to apply a suitable lubricant.

Please observe the following requirements in all cases when fastening the fixing system:

- Minimum distance from the centre of the bore to the edge of the concrete pad: 2.84 in (72 mm).
- Minimum diameter of the hole drilled in the concrete pad: 0.32 in (8 mm).
- Minimum depth of the hole drilled in the concrete pad: 2.56 in (65 mm).
- Minimum thickness of the concrete pad: 3.94 in (100 mm).
- Tightening torque: 177.02 lb.in (20 Nm).
- Minimum depth of anchoring bolt: 1.77 in (45 mm).

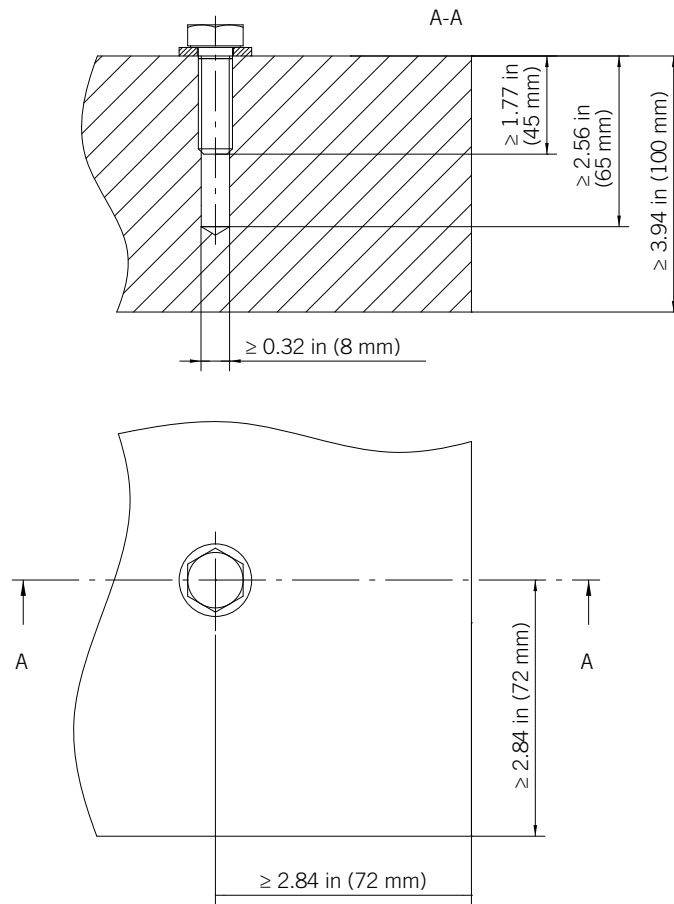

These are the main dimensions of the fixing plates:

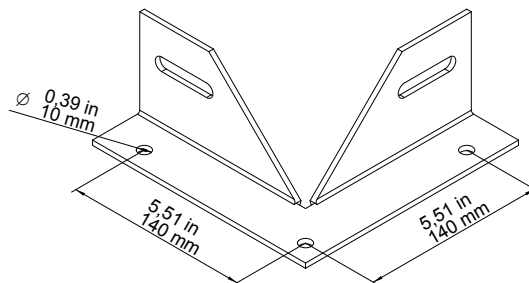

The dimensions of the unit are as follows. Bear in mind the clearance between the pins of the fixing strips (if any) and the floor:

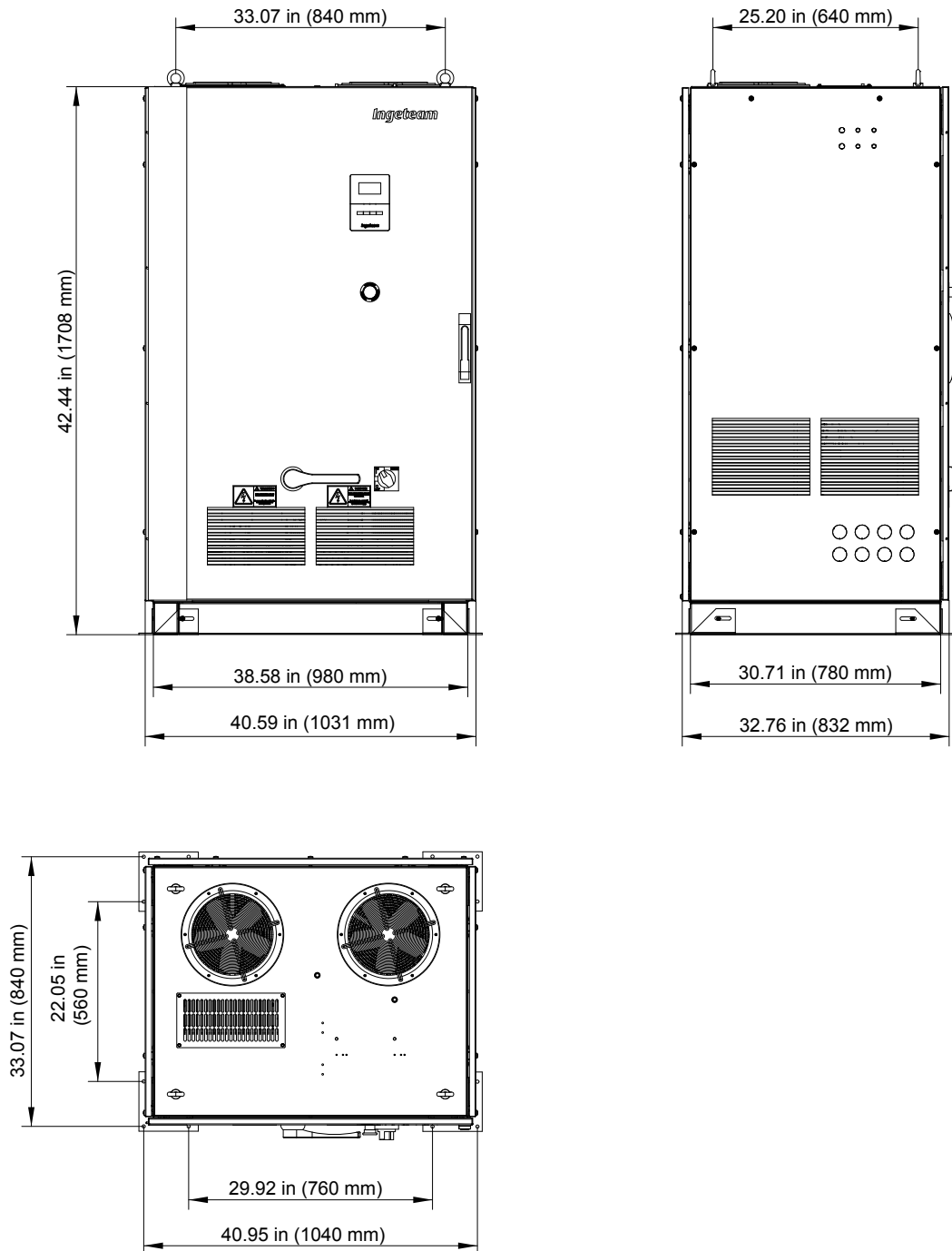

Once the location of the equipment has been selected, follow these steps:

1. Mark the fixing points for the strips on the floor.
2. Drill the floor with a recommended drill for the fixture supplied with the fastening plate.
3. Anchor the fixing strips to the floor.
4. Screw the fixing plates to the unit.
5. Check that the unit is properly secured.

5.3. Insulation monitor

For installations that so require, the installer will connect an IT network insulation monitor.

The insulation monitor should be capable of withstanding and be able to measure 280 VDC and 630 VDC for INGECON SUN 100 U 208 and INGECON SUN 100 U 480 units respectively.

The unit's insulation monitor controls the IT network when the unit is powered up.

5.4. Electrical connection

Once the unit has been mounted in its final position and has been solidly secured, make the electrical connections to it.

Care must be taken to ensure the equipment is not live when accessing its interior.



The front door of the cabinet is arranged so that it can only be opened when the AC thermomagnetic circuit breaker, the DC circuit breaker and any auxiliary external supplies are disabled.

When checking that there is no voltage, wearing dielectric gloves and safety goggles approved for electrical hazards is required.



While the door is open, do not alter the position of the thermomagnetic circuit breaker or isolating switch, do not operate the controls on the door nor apply force to the internal electrical devices which they control.

They must also be in the OFF position for the door to be able to be closed.



After setting the AC thermomagnetic circuit breaker, the DC isolating switch and any auxiliary external supplies to OFF, wait at least 10 minutes before opening the door. Internal capacitances may still hold hazardous voltages.

During inspection and handling work:



Take care, since even with the AC thermomagnetic circuit breaker and the DC isolating switch on OFF, cables directly connected to the grid or panels may still have dangerous voltages. This includes feed strips wires between switches/breakers.



As long as the panels are exposed to the light, the DC cables will carry potentially dangerous voltage levels.

During handling work:



Remove all sources of voltage to the equipment: the grid, the PV array and any auxiliary power supply.



After setting the AC thermomagnetic circuit breaker and DC isolating switch to OFF, wait at least 10 minutes before opening the door. Internal capacitances may still hold hazardous voltages.



Once the equipment is open, check there is no electrical hazard in the voltage inputs from the grid, the PV array or any auxiliary supply.

When checking that there is no voltage, wearing dielectric gloves and safety goggles approved for electrical hazards is required.

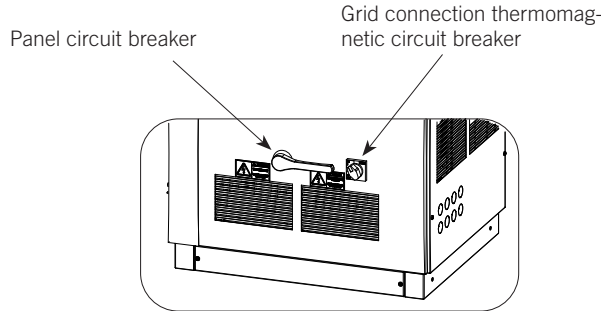

5.4.1. Description of cable inlets

Power cables for INGECON SUN 100 U access the equipment via glands in the bottom of the cabinet or alternatively via glands in the lower sides of the cabinet on both the left and right sides. The following drawings show these glands.

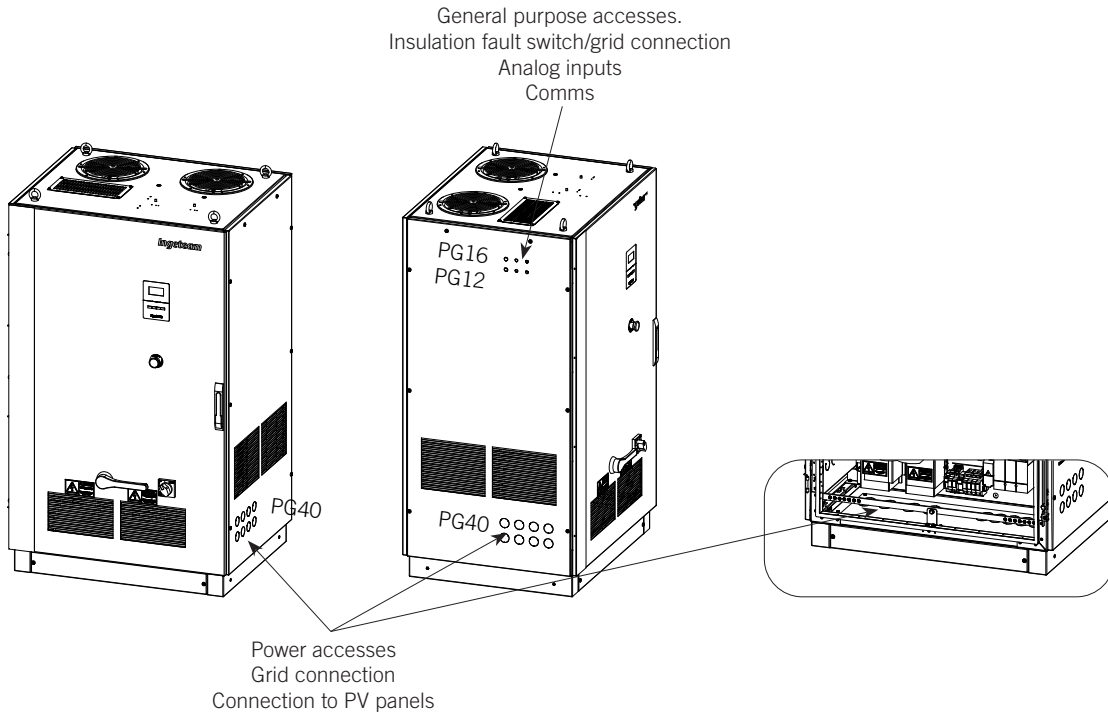

Access for communication cables or auxiliary inputs is located on the top of the left side of the DC cabinet. They are shown in the above diagram.

The tapered grommets allow wire diameter of up to 1.57 in (40 mm).

Care must be taken to ensure the equipment is not live when accessing its interior.



All the doors on the cabinet are arranged so that they can only be opened when the AC thermomagnetic circuit breaker, the DC isolating switch and any auxiliary external supplies are disabled.

When checking that there is no voltage, wearing dielectric gloves and safety goggles approved for electrical hazards is required.

While the door is open, do not alter the position of the thermomagnetic circuit breaker or isolating switch, do not operate the controls on the door nor apply force to the internal electrical devices which they control.

They must also be in the OFF position for the door to be able to be closed.

After setting the AC thermomagnetic circuit breaker, the DC isolating switch and any auxiliary external supplies to OFF, wait at least 10 minutes before opening the door. Internal capacitances may still hold hazardous voltages.

During inspection and handling work:

Take care, since even with the AC thermomagnetic circuit breaker and the DC isolating switch on OFF, cables directly connected to the grid or panels may still have dangerous voltages. This includes feed strips and wires between switches/breakers.

As long as the panels are exposed to the light, the DC cables will carry potentially dangerous voltage levels.

5.4.2. Description of cabling connections

INGECON SUN 100 U units have the following cabling connections:

- Plates for DC connection.
- AC connection terminals.
- Terminal strips for connecting the insulation fault indicator.
- Copper bar with threaded holes for earthing connection.
- Connecting the 230 V auxiliary supply (optional depending on the model and kit included).



CAUTION:

As long as the panels are exposed to the light, the DC cables will carry potentially dangerous voltage levels.

Never handle the connections before disconnecting the inverter from the grid and the PV array.

5.4.3. Order of connecting the unit

The basic connections to be made with the INGECON SUN 100 U units are as follows, in this order:

1. Connecting the insulation failure detection switch (optional)
2. Communication line (optional)
3. Connecting the various grounding connections
4. Connecting the auxiliary supply (optional depending on the model and kit included)
5. Connecting the 3-phase inverter system to the power grid
6. Connecting the DC cables from the PV array

The following sections describe how to make these connections.

5.4.4. System wiring diagram

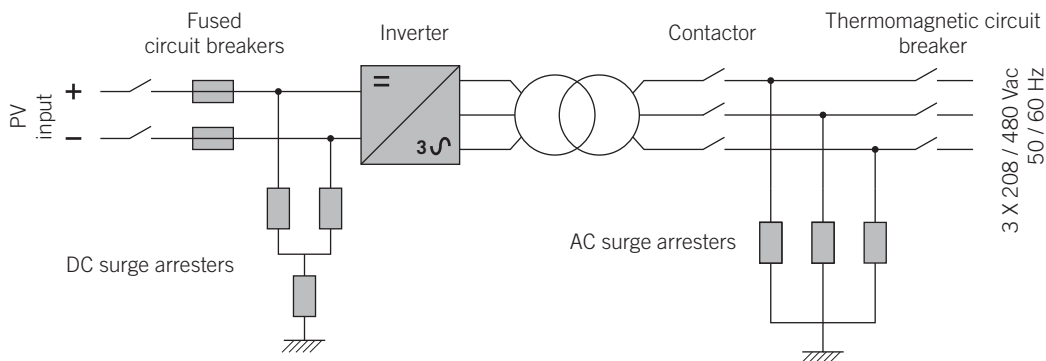

5.4.5. Insulation fault contact / grid connection indicator

The inverter incorporates a normally open volt-free auxiliary contact. It can be used for one of two functions:

- Detection of insulation fault in the DC circuit.

Open contact: there is no insulation fault in the DC circuit.

Closed contact: there is an insulation fault in the DC circuit.

- Indicator showing that the unit is connected to the mains via its internal contactor.

Open contact: internal contactor for connecting to the grid is open; the inverter is not connected to the grid.

Closed contact: internal contactor for connecting to the grid is closed; the inverter is connected to the grid.

The unit always measures the insulation separately from the contact configuration.



The configuration of the equipment to make the contact perform one or another function is factory set and must be specifically requested from Ingeteam at the time of ordering.

This normally open contact withstands a voltage of 230 Vac and a maximum current of 10 A.

The terminals used are X5.1 and X5.2.

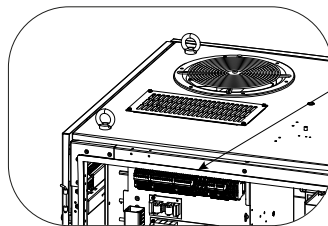
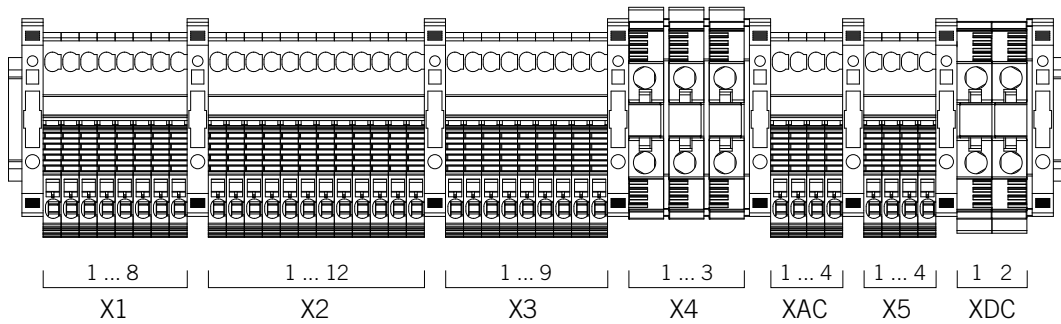

5.4.6. Access to auxiliary connections

Some PV installations require the inverter to be connected to auxiliary equipment, such as solar radiation sensors, heat sensors and anemometers.

Consult the manufacturer when ordering.



For best performance, the cables carrying these auxiliary signals will be removed from the power cables.

5.4.7. Connection for communication via RS-485 serial port

These INGECON SUN 100 U units incorporate hardware for communicating via an RS-485 serial line. This hardware is made up of an "AAP0022 Com RS-485" board supplied ready mounted in the control board in the power block. To access the board, use the access points indicated in 5.4.1.



The unit is provided with a >211 Ohm ferrite rod. The cable coming out of the "AAP0022 Com RS-485" board must be inserted as close as possible to the board, turning it twice around the hole at its centre.

For more information on board operation, see "AAX2002IKI01 Installation Guide for Communications Devices".

5.4.8. Connection for communication via modem-GSM/GPRS + RS-485

At the request of the installer, inverters may optionally be equipped with hardware for communication via GSM/GPRS phone. This hardware is made up of an "AAX0001 Com GSM/GPRS + RS-485" board and the antenna for the modem.



The unit is provided with a >211 Ohm ferrite rod. The RS-485 cable coming out of the "AAX0001 Com GSM/GPRS + RS-485" board must be inserted as close as possible to the board, turning it twice around the hole at its centre.

The board is provided with a bag (attached with a plastic tie) containing the modem antenna and cable. Connect the rod cable to the cable's rod output, and feed it out through the holes on the upper left side of the enclosure. Connect the end that goes outside to the rod and attach it via its magnet to the unit's enclosure.

Connect the rod cable to the cable's rod output, and feed it out through the holes on the upper left side of the enclosure. Connect the end that goes outside to the rod and attach it via its magnet to the unit's enclosure.

See "AAX2002IKI01 Installation Guide for Communications Devices".

The modem should be connected to the control board using connectors J11 and J12 on the board.

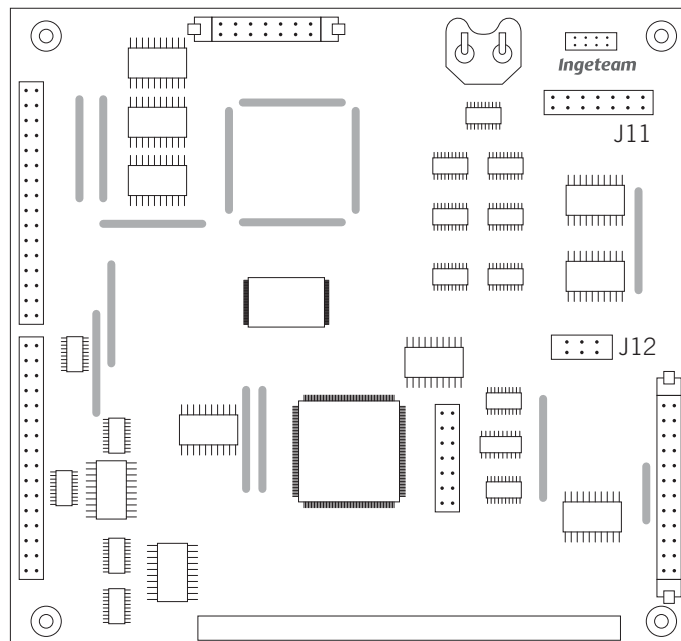

Control board. Fix to connectors J11 and J12

The control board can be found in the electronics block cabinet.

Turn the comms board so that the connectors can be seen.

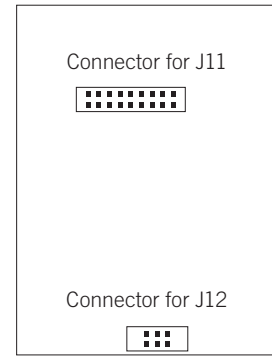

Communications board, rear view

Connect the communications board exactly as shown in the following illustration.

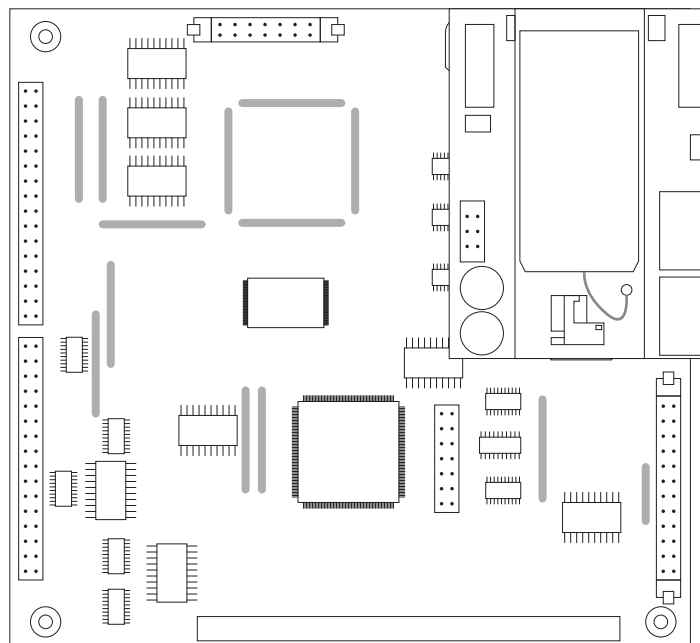

5.4.9. Connection for Ethernet communication

At the request of the installer, inverters may optionally incorporate hardware for communicating via ethernet. This hardware is made up of an "AAX0004 Com Ethernet + RS-485" board.



The unit is provided with a >211 Ohm ferrite rod. The cable coming from the "AAX0004 Com Ethernet + RS-485" board (RS-485 output) must be inserted as close as possible to the board, turning it twice around the hole at its centre.

The board is provided with a bag (attached with a plastic tie) containing the Ethernet cable. Connect the cable to the board's Ethernet output and feed it out through the holes on the upper left side of the enclosure.

See "AAX2002IKI01 Installation Guide for Communications Devices".

Follow the same instructions given in the previous point for the connection of the board to the control board.

5.4.10. Ground connections

The metal parts of the inverter (equipment ground) are electrically connected to the grounding bar on the front of the cabinet.

To ensure the safety of personnel, this terminal must be connected to the installation's ground.

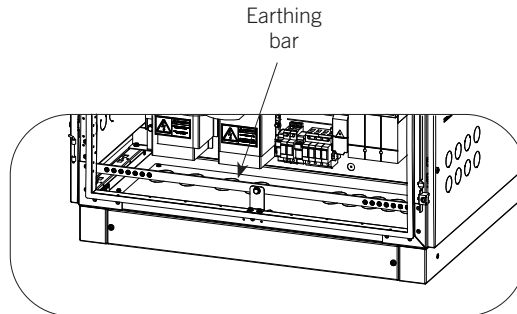

5.4.11. Grid connection

The cables for connecting the unit to the grid enter through the glands at the base of the cabinet. They must withstand at least the phase voltage and 1000 V between a phase and ground.

If the inverter and the grid connection point are far enough apart to require the use of longer cables, an external distribution box must be used close to the investor to make this connection.



The cable gauge must be suitable in each case for the power rating of the unit and site conditions.

Protections for the connection of inverters to the electrical grid can withstand a short-circuit current of up to 70 kA.



Before any handling, check that there is no electrical hazard in the voltage input from the grid.



When checking that there is no voltage, wearing dielectric gloves and safety goggles approved for electrical hazards is required.

INGECON SUN 100 U models with a transformer have four bimetallic terminal strips (three-phase plus neutral) for connection to the electrical grid. The maximum allowable gauge for these terminal strips is 0.14 in² (95 mm²) in each phase.

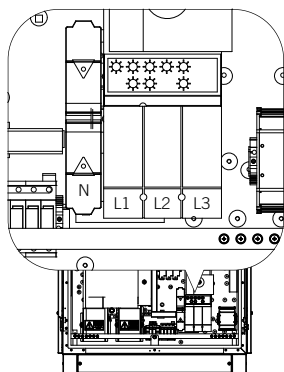

INGECON SUN 100 U 208

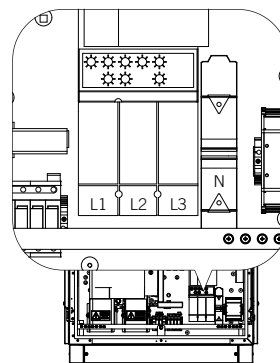

INGECON SUN 100 U 480



Ingeteam recommends the connection of the neutral on INGECON SUN 100 U units.

To avoid arcing, once the wires are connecting to the terminals, check the safety clearances between live parts on each strip or any other metal point on the unit. We recommend a clearance of 0.79 in (20 mm).



After working on the terminals the polycarbonate guard must be put back into place.

5.4.12. Connecting to the PV array

The cables for connecting the unit to the PV array enter through the conical glands in the base.



Before any handling, check that there is no electrical hazard in the voltage input from the PV array. Never forget that whenever they receive solar radiation, the panels' terminals generate voltage. The inverter can therefore have voltages of up to 1000 V inside even when not connected to the grid. When checking that there is no voltage, wearing dielectric gloves and safety goggles approved for electrical hazards is required.



CAUTION
Connect the positive pole of the panel series to the terminals marked ⊕, and the negative pole to the terminals marked ⊖.

If the distance between the inverter and the PV array connection point requires the use of longer cables, an external distribution box must be used close to the inverter to make this connection.

The units have two copper strips with two 0.51 in (13 mm) diameter orifices for fitting M12 size ring-terminated cables.

The maximum gauge recommended by Ingeteam for these wires is 4 times 0.37 in² (240 mm²). In each hole a cable can be connected from each side of the strip. So up to four cables can be connected to each strip.

To avoid arcing, once the wires are connecting to the strips, check the safety clearances between live parts on each strip or any other metal point on the unit. We recommend a clearance of 0.79 in (20 mm), with a minimum of 0.40 in (10 mm).

To access these terminals the protective polycarbonate sheet must be removed.

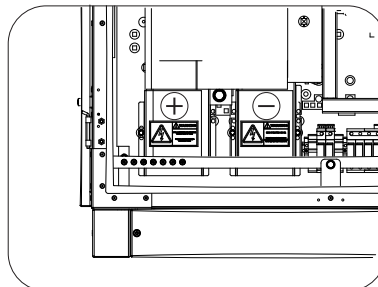

To access these terminals the protective polycarbonate sheet must be removed.



After working on the terminals the polycarbonate guard must be put back into place.

5.5. Grounding

The PV array is grounded by a fuse connecting one pole of the PV array, negative or positive, to ground. The polarity of the connection depends on the type of panel technology.

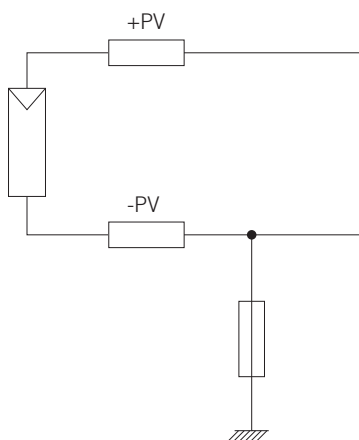

Grounding the negative pole

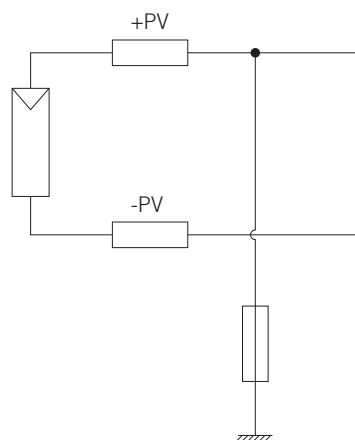

Grounding the positive pole

The fuse will open the PV array connection to ground when an insulation fault in the PV array generates a current through the connection which is greater than the fuses release current.

The unit is delivered together with a loose fuse. For grounding the positive pole, install it in fuse holder F9. Alternatively, if you wish to ground the negative pole, install it in fuse holder F10. (see figure below).

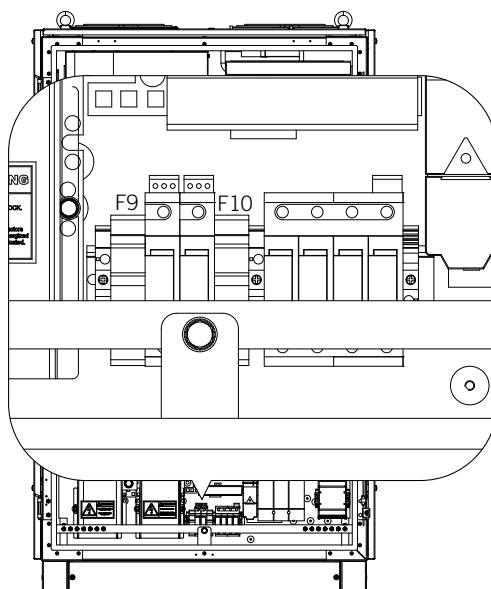

In addition, the grounding configuration should be set up using the display (see Section "8.6.5. Ground connection").

The current generated by the panels is closed by the lack of a positive pole, closing via the negative pole connection, until it returns to the panel. When the current exceeds the thermal value of the protection (10 A), the circuit is opened and current ceases to flow to ground.

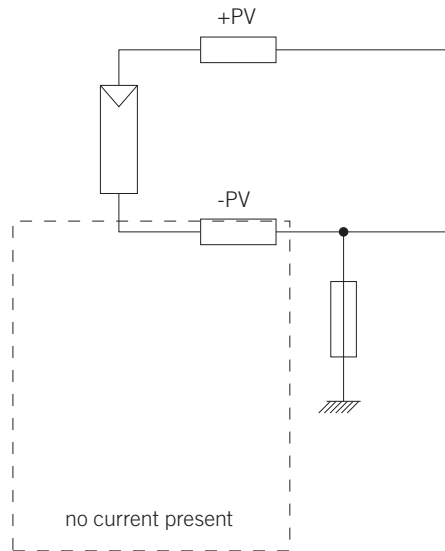
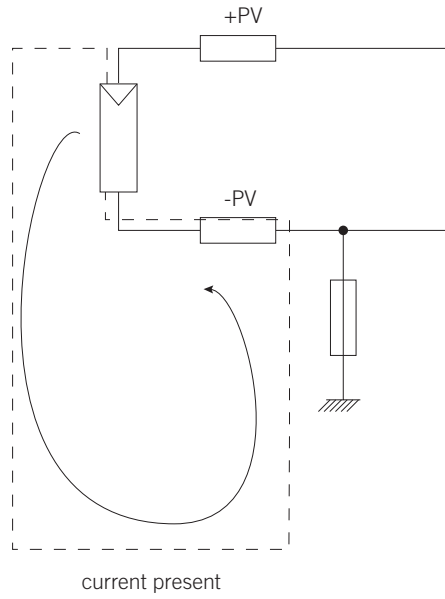

If there is an insulation fault in the system on the same pole connected to ground by the protection, this fault is not detected. This situation does not generate current flow.

In this situation there is no reason for a second fault to be detected by the protection. Since two return paths are created, one by the protection and one by the insulation fault of the second pole.

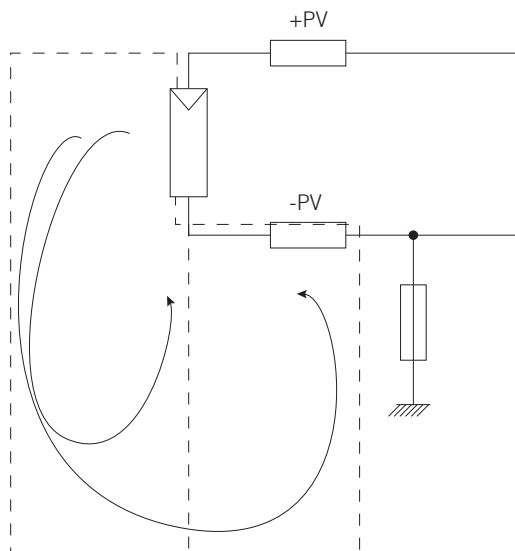

To avoid this situation, check that there are no insulation faults in the grounded pole by inspecting the installation. This procedure should be carried out in compliance with the security measures described in this manual.

Turn off the unit to perform the following procedures

1. Measure the voltage between positive and negative in the panel (V_{oc})
2. Measure the voltage between the positive pole and ground (V_P)
3. Measure the voltage between the negative pole and ground (V_N)

The PV array will be properly insulated if V_P and V_N are less than the value of V_{oc} divided by two.

If V_P or V_N have a value greater than $V_{oc}/2$, the PV array will have faulty insulation in one of its parts.

The protection will be monitored by the inverter control, and when the breaker opens the connection of the PV array to ground, the control will shut down the unit, triggering the 0x0200 DC Protection alarm.

6. Commissioning

6.1. Equipment inspection

INGECON SUN 100 U units are fitted with a series of thermomagnetic circuit breakers to protect various components. These should be closed prior to unit start-up.



Before working on the thermomagnetic circuit breakers, check that there are no electrical hazards inside the unit.

When checking that there is no voltage, wearing dielectric gloves and safety goggles approved for electrical hazards is required.

6.1.1. Inspection

Before inverter start-up, a general inspection of the units must be carried out involving mainly:

Wiring

- Check that there are no loose wires. The insulation clearance is 7.87 in (200 mm) between cables.
- Check that the protective switchgear such as thermomagnetic circuit breakers, switches, arresters and fuses in general are in the correct position and in proper working condition.

Removing the perspex-type protections for performing this inspection is strictly forbidden.

DC feed

Check that the DC arresters are properly inserted into the base and that their "status window" is not red.

Equipment

- Check that the protective thermomagnetic circuit breakers are in the correct position.
- Check also that the fuses (DC intake) are correctly fitted.

AC feed

The following checks must be made to the AC feed.

- Auxiliary thermomagnetic circuit breaker switched to ON.
- Fuses correctly inserted into their sockets.
- Arresters correctly inserted into their sockets. Check that the status window is not red.

6.1.2. Shutting down

During installation, make sure that the protection grade of the equipment has not been altered.

In all connections through cable glands, give cabling enough length inside the unit so they don't pull on the internal electrical connection terminals.

Ensure that unused glands have been properly sealed.

Safety measures

Opening the front door of the cabinet is conditional on both the AC thermomagnetic and the DC circuit breaker being in the OFF position. The must also be in that position for the door to be closed.



Do not alter the position of the AC thermomagnetic or the DC isolating switch with the door open. Do not operate the controls on the door nor apply force to the internal electrical devices which they control.

6.2. Start-up

First carry out a general visual inspection and wiring check, then proceed to connect power to the unit while keeping it switched off, following the guidelines in the instruction manual of the unit.

The tasks outlined for this step must be carried out with the unit door always closed, thus avoiding possible contact with live parts without IP2X protection.

6.2.1. Start-up

Check that the inverter switches on and gives no alarm except for manual shutdown. Next, check that the variables on the monitoring menu are consistent; in particular the Vac Vdc levels.

The Vdc reading shows the voltage of the PV array at any given moment.

It allows you to check that the PV array is balanced. To do this, click "OK" on the Vdc display screen and confirm that the displayed PVP and PVN values (indicating the voltage of each PV array pole to ground) are similar.

Finally, check that the inverter only displays the manual stop alarm (Alarm 1000H) on the monitoring menu.

Once the tasks described above are performed, you may proceed to start the inverter. Failure to comply with the verification tasks described above releases Ingeteam from any liability for possible damage to the system or the inverter itself caused by such failure.

Proceed to start the inverter.

6.2.2. Checking and measurement

Once connected to the unit network, the LED "Start" is lit, verify that no error LED display is on.

Check that the monitoring menu parameters are consistent:

- The voltage of the PV array should be within normal values and must remain balanced (similar PVN and PVP).
- Vac tension shown on the display must fall within operating ranges.
- The RMS value of currents Iac1, Iac2 and Iac3 displayed should be similar.
- There are no alarms in the inverter (0000H).

It is always advisable to check the waveform of the current generated in the three phases using an ammeter clamp. Use the PPE listed in the "Personal Protective Equipment" section (working with voltage) to get this reading.

7. Preventive maintenance

The recommended preventive maintenance tasks must be carried out at least **annually**, except for the checking the fans and filters, which must be done **monthly**.



The various maintenance tasks must be performed by qualified personnel. Danger of electric shock.



To access the various compartments, take into account the safety recommendations in previous chapters.



All maintenance checks listed here should be done **with no voltage on the inverter** and in safe conditions for handling.

The following paragraphs describe the actions to follow for proper installation of INGECON SUN 100 U inverters.

7.1. Maintenance tasks

Check status of the enclosure

A visual check of the status of the enclosure must be performed, verifying the status of locks, doors and handles and the unit fixings at both lower and, if any, upper anchorage points. In addition, the condition of the enclosure must be checked for dents, scratches or rust that might degrade the cabinet or cause it to lose its protection classification. If this type of defects are noticed, the parts affected must be substituted.

Check the status of the cables and terminals

- Check the correct path of the cables so they do not come into contact with live parts.
- Check for insulation faults and hot spots by checking the colour of the insulation and terminals.

Tightness of strip fasteners and power cables

Check tightness in accordance with the following torques:

Threads dimensions	Tightening torque
5/16" (M8)	216 lb.in (24.5 Nm)
3/8" (M10)	385 lb.in (43.5 Nm)
7/16" (M12)	650 lb.in (73.4 Nm)

As per DIN 13.



In order to keep the nuts and bolts of the equipment in a proper condition, it is important while tightening them to make sure there is no dirt or shavings on the threads and to apply a suitable lubricant.

Check strips

Visually check that the AC feeds comply with safe distances and maintain their initial electrical properties.

Check that there is no moisture inside the cabinet

If moisture exists, dry before making electrical connections.

Fixings

Check the correct fixing of the cabinet components to their corresponding anchorage points.



In order to keep the nuts and bolts of the equipment in a proper condition, it is important while tightening them to make sure there is no dirt or shavings on the threads and to apply a suitable lubricant.

Ensure adequate ventilation of the unit

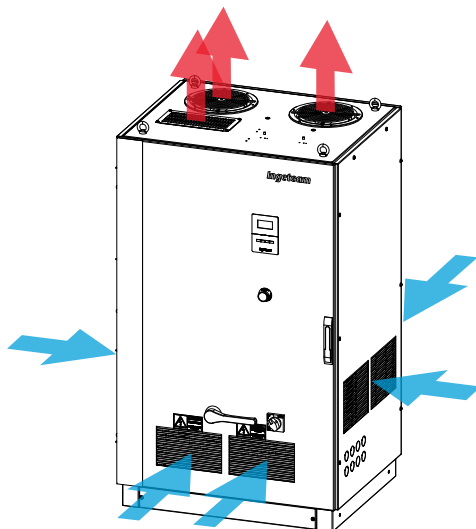

Checking the status of exhaust fans, cleaning and replacing them if necessary.



The useful life of the fans is 4 years, so they must be replaced after this time even if they seem to be functioning normally.

Clean vents grids

Check the state of the filters in the front and side ventilation grids.

To do this you must first remove the grille of the air intake, behind which is the filter.

- Unscrew the four nuts from the grid, accessible from the inside of the door.
- Remove the grid.
- Remove the filter from inside the grid.

Accumulated dust and dirt in the filter may adversely affect the cooling ability of the fan and result in anomalous heating of the equipment. To solve this problem, clean and replace the filter and grid:

- With a moderately dirty, dry filter, lightly tap until the dirt has been removed.
- If the dirt does not disappear, wash in water at 104 °F (40 °C).
- If the filter is soiled with grease or oil, replace it with a new one.

If the problem persists, contact Ingeteam.

When on, the inverter generates a buzzing sound.

Check the environment to avoid amplifying or transmitting the buzz.

The unit should be located in a place readily accessible for installation and maintenance work, enabling keyboard handling, display reading and access to the unit's various internal components.

8. Display control

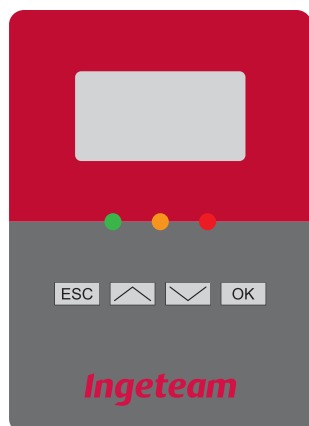





INGECON SUN 100 U inverters incorporate a “Display + Keypad” unit to interface with the installer and the user.

This interface allows the display of the main internal parameters and the configuration of the entire system during installation.

Parameters, variables and commands are organised as menus and submenus.

8.1. Keypad and LEDs

The keypad has four keys:

- | | |
|---|---|
|  | Esc. To exit a parameter, leave a menu and returning to the next level up in the structure, to not confirm a change or not accept a suggestion. |
|  | Up. With this key you can scroll up the list of parameters or folders within the same level or increase the value of an editable parameter by one base unit. |
|  | Down. With this key you can scroll down the list of parameters or folders within the same level or decrease the value of an editable parameter by one base unit. |
|  | OK. Serves to accept a parameter as valid, to enter a lower level menu in the structure, to confirm a change or accept a suggestion. |

The front panel has three LEDs:

- **Green LED**
 - Slow flashing: Standby due to low irradiance.
 - Fast flashing: Start-up process.
 - On: Inverter connected to the grid.

- **Orange LED**

Fast flashing: Alarm set off which does not shut down the inverter.

- **Red LED**

On: Alarm set off which shuts down the inverter.

- ●
●
Special combinations

Rapid flashing of all three LEDs: Fatal error status.

8.2. Display

The current date and time on the top line. The internal clock automatically changes the time from summer to winter and vice versa.

The node number for which data is being viewed appears beneath the top line on the left.

The central section provides instantaneous PV array voltage, power fed in by the inverter and output voltages.

The bottom line displays the functions for each of the keys.

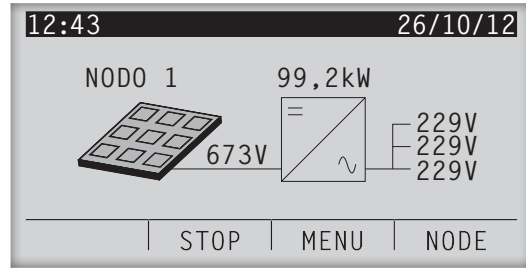

If the inverter is manually shut down, the display will read "STOPPED" instead of displaying the power fed in by the inverter.

In the initial screen, in normal operation, the keypad functions are as follows:

 Manual shutdown.

 Main menu access.

 Change node.

If there are any active alarms in the inverter, the bottom, empty box will flash "ALRM" and the **ESC** key will also have its function:

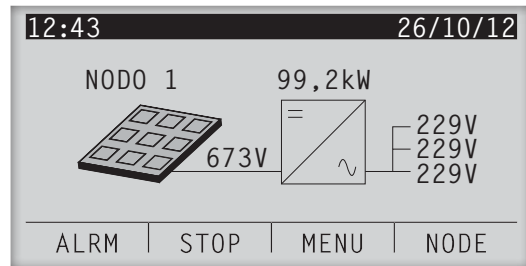

ESC you can see all the alarms which are active at that moment.

For example:

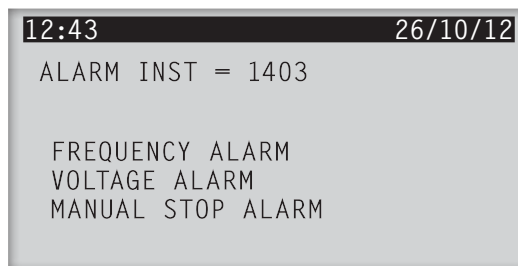

To exit this screen, press **ESC** again.

8.3. Main menu

The main menu contains the following submenus:

- Monitoring. This displays the main internal parameters and variables that indicate the operation status of the unit.
- Reasons for shutdown. This option shows the reasons why the inverter was shut down the last five times.
- Settings. This menu displays all the settings that affect the inverter.
- Inverter data. This option offers inverter-specific data.

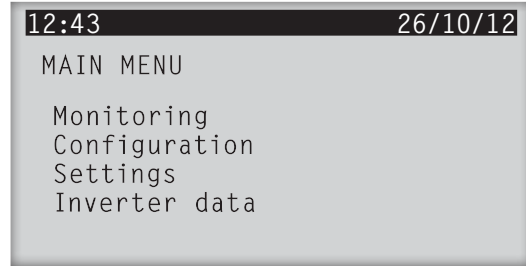

8.4. Monitoring

This menu is accessed by pressing the **OK** key in the Monitoring menu.

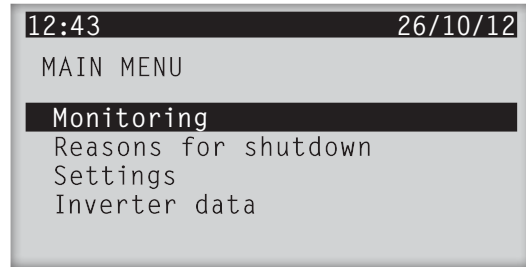

See below for the structure and interpretation of the variables in this menu:

Screen 1

- Pac** Power inverter is delivering into the grid, in kW.
- Pdc** Power supplied by solar panels, in kW.
- Etot** Total energy in kWh delivered by the inverter to the grid from the date it was manufactured.
- ParE:** Total energy in kWh delivered by the inverter to the grid since the last time the counter was reset.

Screen 2

- Vdc** Voltage supplied by solar panels to the inverter.
- Vac1** Inverter output voltage in phase one of the grid.
- Vac2** Inverter output voltage in phase two of the grid.
- Vac3** Inverter output voltage in phase three of the grid.

Screen 3

- Idc** Current supplied by solar panels to the inverter.
- Iac1** Inverter output current in phase one.
- Iac2** Inverter output current in phase two.
- Iac3** Inverter output current in phase three.

Screen 4

- Frec1** Phase one frequency.
- Frec2** Phase two frequency.
- Frec3** Phase three frequency.
- Cos.Phi** Cosine of Phi. Cosine of the phase shift angle between grid voltage and current supplied by the inverter.

Screen 5

Rpv	Impedance of the entire PV array to ground.
Rpv+	Impedance of the positive pole of the PV array to ground.
Rpv-	Impedance of the negative pole of the PV array to ground.

Screen 6

Alarms Status of inverter alarms.

0000H	No alarms.
0001H	Grid frequency out of range.
0002H	Grid voltage out of range.
0004H	PI current saturation.
0008H	Unexpected reset.
0010H	Continuous overload at output.
0020H	Temperature alarm in the power electronics.
0040H	Hardware fault. Synchronization fault.
0080H	Instantaneous overload at output.
0100H	AC circuit protection.
0200H	DC circuit protection.
0400H	Insulation fault.
0800H	Power electronics fault.
1000H	Manual shutdown alarm.
2000H	Configuration change alarm.
4000H	Panel input overvoltage.
8000H	Low voltage in the PV array.

Alarms Hist Alarms since the last connection. This value is reset each time the inverter is connected to the grid. It has the same code as the "alarms" variable.

TempInt Inverter power electronics temperature.

TempCl Inverter control electronics temperature.

Screen 7

Conn.N Number of grid connections made during all hours of operation.

ParConn.N Number of grid connections since counter was last reset.

ConnT Number of hours the inverter has been connected to the grid.

Par.ConnT Number of hours the inverter has been connected to the grid since the counter was last reset.

8.5. Reasons for shutdown

This menu shows the last five inverter shutdowns, with reasons and corresponding date and time.

```

12:43                               26/10/12
REASONS FOR SHUTDOWN
13:43 (08/01) -> MAN SHUTDOWN
17:22 (08/01) -> POT CURRENT
19:35 (07/01) -> POT CURRENT
12:21 (05/01) -> FRED
15:51 (04/01) -> POT CURRENT

```

Meaning of reasons for shutdown:

MP VIN	High input voltage from the panels.
MP FRED	Incorrect grid frequency.
MP VRED	Incorrect grid voltage.
MP VARISTORES	Varistor fault.
MP AISL.DC	DC insulation fault.
MP INT AC RMS	Continuous overvoltage on AC output.
MP TEMPERATURA	Excess temperature in the power electronics.
MP CONFIG	Shutdown for configuration change.
MP PARO MANUAL	Manual shutdown.
MP B VPV MED	Low panel input voltage.
MP HW_DESCX2	Internal fault.
MP IAC INST	Voltage surge on AC output.
MP CR. FIRMWARE	Shutdown due to firmware change.
MP LEC ADC	AD converter (internal) reading fault.
MP CONSUMO POT	Insufficient solar radiation. Does not trigger alarm.
MP FUSIBLE DC	Input fuse fault.
MP TEMP AUX	Redundant temperature sensor fault.
MP PROTECCION AC	AC Protection.
MP MAGNETO AC	Thermomagnetic circuit breaker error.
MP CONTACTOR	Contactors failed to close.
MP RESET_WD	Stopped for Watch Dog reset (internal).
MP LAT ADC	Converter (internal) fault.
MP ERROR FATAL	Fatal error in the inverter.
MP FALLO RAMA1	Power electronics fault.
MP FALLO RAMA2	Power electronics fault.
MP FALLO RAMA3	Power electronics fault.
MP PI CORR SAT	PI current saturation (internal).
MP LATENCIA SPI	Communication fault with redundant system.
MP REDUNDANTE	The redundant system has caused a shutdown.
MP PROTECCIÓN PIB	The PIB has caused a shutdown.

8.6. Settings

8.6.1. Date and Time

From this menu you can change the date and time. The internal clock automatically changes the time from summer to winter and vice versa.



8.6.2. Inverter number change



From this menu you can assign the node number to the inverter. This is required for configuring communications.

8.6.3. Language



With this option, you can select the display language.

In the main screen, press the "down" key (an arrow pointing downwards). Main menu access.

From the main menu, by pressing the  or  keys or navigating through the menu to "SETTINGS". Once highlighted, press  to access the submenu.

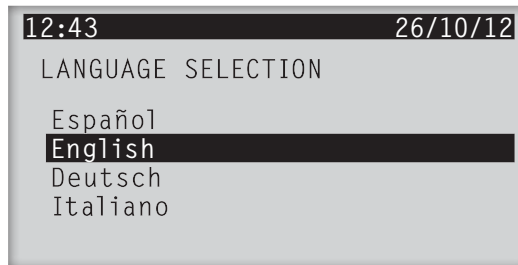
Within the "SETTINGS" submenu with the  or  keys or navigating through the menu to the "Language" option. Once highlighted, press  to access the language change screen.



Press the  button to scroll through the various languages and  to confirm the selection.

8.6.4. Grid quality

In this menu, you can change the grid quality parameters. This menu is only active after the security code has been input.

8.6.5. Ground connection

Through this option, you can change the type of grounding for the PV array. This menu is only active after the security code has been input.

On accessing the *Ground connection* menu, you will be asked for a password. Contact Ingeteam for this password.



Select one of the two options (positive or negative to ground) and press **OK**.

Exit by pressing **ESC**.

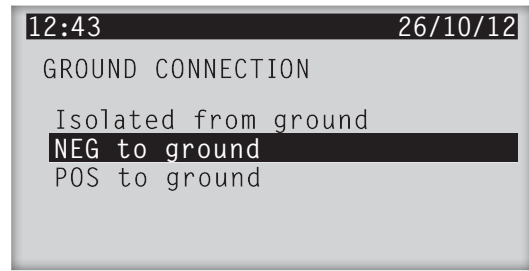

8.6.6. Connection time

This menu allows you to modify the delay before the inverter connects to the grid. This menu is only active after the security code has been input.

8.6.7. Total reset

With this option, the user can reset all inverter counters. This menu is only active after the security code has been input.

8.6.8. Other adjustments

Various internal adjustments.

8.6.9. Change NumCAN

From this menu you can change the node number. This is useful for units with more than one electronics block, and should not be changed on the unit unless so instructed by Ingeteam.

8.7. Inverter data

This window displays inverter-specific data:

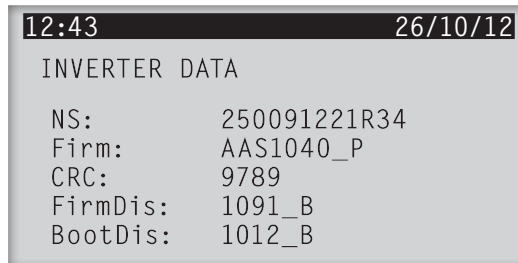

Serial Number (SN)

Number that identifies the inverter.

Firmware Version (Firm)

Shows the name and version of the inverter firmware.

Display firmware version (FirmDis)

Shows the name and version of the inverter display.

Boot version of the display (BootDis)

Shows the name and version of the display Boot.

8.8. Change inverter number

From this menu you can assign the inverter a number. This is required for configuring communications.

Use the **▲** and **▼** keys to change the inverter number. Press **OK** to confirm the number selected.

9. Troubleshooting

This is a guide for troubleshooting problems that may arise in the installation of your INGECON SUN 100 U unit. It also explains how to perform simple operations such as component replacement and unit configuration.



Troubleshooting for the INGECON SUN 100 U unit must be performed by qualified personnel in compliance with the general safety instructions in this manual.

9.1. LED messages

Some of the LEDs indicate some kind of problem in the PV installation.

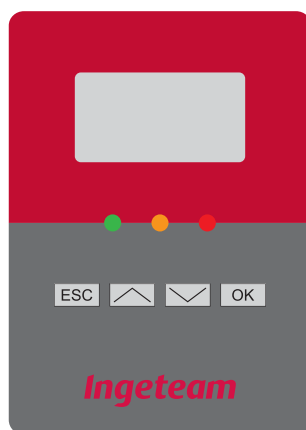

INGECON SUN 100 U 208 display

9.1.1. Green LED

This is the LED that should light up in normal start-up and operating conditions, while the others remain off. It has three modes:

Slow flashing

Standby due to low solar radiation. Flashing every 3 seconds. This alarm is triggered when the PV array does not receive enough solar radiation to supply the minimum voltage required by the inverter to inject power. This occurs commonly between sunset and sunrise, or at times when rain, clouds or other atmospheric phenomena produce overcast conditions above the PV array.

If this situation occurs on a day which is not particularly dark, check that the panels are clean and properly installed.

Fast flashing

This type of blinking indicates that the PV array is feeding the right amount of voltage to the inverter and it is about to start up. In this state, the inverter checks the grid parameters to feed current into the grid at the latter's precise voltage and frequency. This process takes about 1 minute (adjustable).

Steady light

Inverter connected to the grid.

9.1.2. Orange LED

This LED indicates that alarms have been set off in the inverter.

Fast flashing

This flashing indicates that an alarm has occurred in the inverter, but the anomaly in the operation does not require stopping the inverter. The most frequent alarm of this type is the high temperature protection:

The inverter is in self-limiting mode because it has reached the maximum permissible temperature.

In this situation, check that the fans are running, that the air inlets and vents are free from obstacles, and that there are no sources of intense heat near the inverter. If the problem persists, contact Ingeteam.

9.1.3. Red LED

This LED indicates that alarms have been set off in the inverter.

Steady light

The inverter shuts down. This flashing indicates that an alarm has occurred in the inverter which requires it to shut down. The most common alarms that require inverter shutdown are:

1000H Manual shutdown. The unit has been stopped manually. Check that the emergency push buttons have not been pressed accidentally, and try to restart from the display by removing the manual shutdown.

0001H Grid frequency out of range.

0002H Grid voltage out of range.

Chances are that the problem is a power failure. When power returns, the inverter will restart. If not, check the connections to the grid.

If the grid has the appropriate grid quality parameters, check the grid connections.

If the problem persists, contact Ingeteam.

0400H Insulation fault in DC circuit.

There are two possible causes:

- There is an insulation fault on the panel circuit.
- An arrester has triggered.

0020H Temperature alarm in the power electronics.

The temperature of the unit is too high and has stopped feeding current to the grid. When the temperature drops, the unit will reconnect.



An insulation fault can pose a hazard to personnel.

The repair of an insulation fault must be carried out by qualified personnel.

Procedure to determine the cause of the insulation fault

1. Open the DC isolating switch. If the voltages of the PV array with respect to ground are in balance, the insulation fault is outside the inverter.
2. If the insulation fault persists, the fault is inside the unit. Check the surge arresters.
3. Disconnect the unit from the power grid and the PV array.
4. Wait at least 10 minutes for the capacitances to discharge.
5. Open the inverter and check the status of the DC arresters. Each of these arresters has a visual indicator. If the indicator is black, the arrester has been triggered.
6. Check the status of the DC fuses or thermomagnetic circuit breaker protecting the arresters.
7. Replace defective components if necessary.



8. Close the inverter, reconnect the unit to the grid and to the PV array.
9. If the fault indicator persists, check the PV array insulation. Pinpoint the fault and correct it.

9.2. List of alarms and reasons for shutdown

The following table details the possible reasons for each alarm.

Code	Alarm	Reason for shutdown	Description
0000H		None	No alarm, the unit must be connected whenever it has enough power.
0001H	Frequency	Grid frequency out of range.	Grid frequency out of range.
0002H	Voltage	Grid voltage out of range	Grid voltage out of range
0004H	Current loop	Internal current loop fault.	Internal current loop fault.
0008H	Reset	Reset	Indicates that the inverter has reset, inverter firmware fault
0010H	Effective grid current	Effective grid current	RMS current exceeds maximum allowed
0020H	Temperature	Power electronics temperature.	The temperature of power electronics exceeds 176 °F (80 °C).
		Auxiliary temperature sensor	The auxiliary temperature sensor has triggered an alarm
0080H	Instantaneous grid current	Instantaneous grid current	Instantaneous current value out of range
0100H	AC protections	Varistors	Error in AC varistors
		Contactors	The state of the contactor is not correct for the current inverter status.
		AC protections	Error in some of the AC protectors, arresters, fuses, etc.
		Thermomagnetic circuit breaker	Error in the three-phase input thermomagnetic circuit breaker.
0200H	DC protections	DC protections	Blown DC input fuses or DC arresters
0400H	AC insulation	AC insulation	Insulation fault in the PV array on inside the inverter
		Varistors	Error in DC varistors
0800H	Branch fault alarm	Fault in branch #1	Fault in branch #1 of the power electronics
		Fault in branch #2	Fault in branch #2 of the power electronics
		Fault in branch #3	Fault in branch 3 of the power electronics
1000H	Manual shutdown	Manual shutdown	Manual shutdown with the emergency push button via display or communications
2000H	Configuration	Configuration	Shutdown due to a change in firmware
		Firmware	Shutdown due to firmware load
4000H	High input voltage	High input voltage	High DC input voltage
8000H	Panel voltage	Low input voltage	Shutdown due to low input voltage.
		Hardware fault	Reason for internal shutdown, hardware failure
		Low power	Shutdown due to low power, (typical at nightfall)
		Fatal error	Due to five consecutive errors in the branches, or consecutive contactor shutdowns.

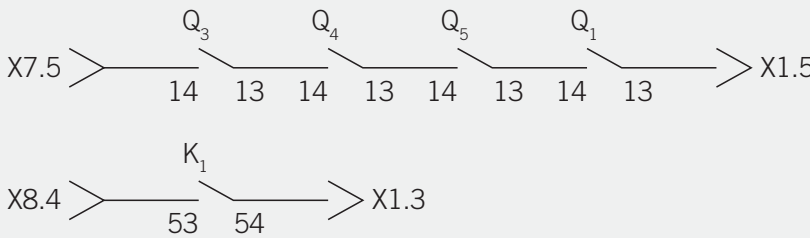
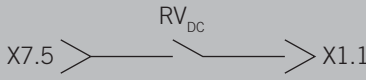
9.3. Inverter alarms due to protections

Code	Description
0100H	<p>This alarm goes off when an AC protection element is triggered.</p> <p>The items monitored are: $Q_1, Q_3, Q_4, Q_5, F_{ac}, RV_{ac}, K_1$</p> <p>Which are the protections for the filters and AC intakes and DC intakes and contactor.</p> <p>In normal operation, all contacts should be closed, except for the contactor circuit. Check the signalling circuit to see where it is broken. The causes may be broken cables in the circuit, a triggered protection, fused arresters or a connector out of its base.</p> 
0200H	<p>This alarm goes off when a DC protection element is triggered.</p> <p>The items monitored are: RV_{DC}</p>  <p>If a grounding kit is used, different protections will have been triggered.</p> <p>The items monitored are: RV_{DC}, Q_{10}</p>  <p>In normal operation all contacts must be closed. Check the signalling circuit to see where it is broken. The causes may be broken cables in the circuit, a triggered protection, fused arresters or a connector out of its base.</p>
4000H	<p>Overvoltages in the panel inputs.</p> <p>This alarms indicates an out-of-range voltage at the PV input.</p> <p>A voltage greater than 900 VDC will cause the equipment to shut down. Voltages greater than 1000 VDC will damage the equipment.</p>
8000H	<p>Very low voltage on the input from the panels.</p> <p>This alarms indicates an out-of-range voltage at the PV input.</p> <p>The equipment will be on standby until the panel voltage reaches the necessary value for a connection.</p>
0020H	<p>Temperature alarm in the power electronics.</p> <p>The temperature of the unit is too high and has stopped feeding current to the grid. When the temperature drops, the unit will reconnect.</p>

9.4. Action protocol for responding to incidents

If the unit should stop interacting with the network due to the emergence of issues relating to the installation and/or the inverter, the fastest way to resolve the issue is as follows:

1. Check on the display the alarm and the reason for shutdown reported by the unit. Search in this guide's index to see if the alarm or reason for shutdown is indicated. If it is covered, proceed to step 2; if on the contrary it is not covered, take note of the unit's serial number and contact Ingeteam's telephonic technical service, the number of which is listed on a sticker on the document pocket behind the door.
2. Disconnect the unit from the supply. This will disconnect both the AC and auxiliary connections by opening the thermomagnetic circuit breaker and the DC isolating switch by opening the PV array breaker. After AC and DC power is switched off, wait 10 minutes before opening the unit, to ensure that their internal capacitance is discharged.



IMPORTANT

Only in the event of an insulation fault triggered by alarm 0400H will the AC power be switched off and the DC power be left.

3. Open the unit and find the section in this guide that deals with the alarm or reason for shutdown recorded in the first step.
4. Use a category III, 1000 V_{DC} multimeter which can measure continuity, resistance and capacitance, and proceed to carry out the checks listed here.
5. If unable to solve the problem using this guide, take note of the unit's serial number and contact technical service.

Below is a list of possible reasons for shutdown, their associated alarms and troubleshooting guidelines. If more than one alarm takes place, the alarm on the display will be the sum of all active alarms.

E.g.:

Code	Alarm
0001H	Grid frequency
0002H	Voltage
0003H	Grid frequency + voltage

9.4.1. Voltage and/or frequency out of range

One reason for shutdown associated with out-of-range voltage and/or frequency features the alarm codes listed below:

Code	Alarm	Reason for shutdown	Description
0001H	Grid frequency	Grid frequency	Grid frequency out of range
0002H	Voltage	Voltage	Voltage out of range
0003H	Grid frequency + voltage	Grid frequency + voltage	Grid frequency out of range + Voltage out of range

In the event of an 0001H and/or 0002H alarm, you must check the status of the Q4 thermomagnetic protection and all the wiring associated with it. This check requires verifying the correct status of the following areas of the unit:

1. Check that Q4 is in the ON position.
2. Check the state of fuses F6, F7 y F8, if they exist.
3. Status of RVac arrester located at the AC feed of the unit on the right. To verify its correct status, verify that they are properly attached to their base and that the status window of none of them is red.
4. When the arresters have been checked, check that the Q1 thermomagnetic (AC circuit breaker of the inverter) is ON.

In the event that Q4 is ON and none of the fuses F6, F7 and F8 are blown, the next step will be to ensure that both the AC voltage intake XAC and the electronic block are powered. The procedure requires performing the following checks:

1. Check that the Q4 thermomagnetic circuit breakers are not damaged. With Q4 switched ON, measure the flow resistance offered by Q4 for each phase. The resistance for each of the phases must be within the 60 to 70 Ohm range. The following figure details the test to be performed.

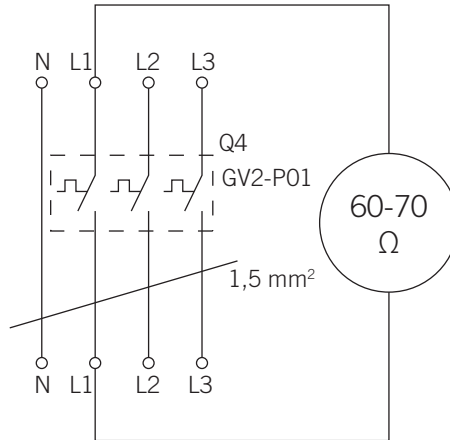

The figure has verified the resistance of phase 1, L1. Testing required for L2 and L3.

2. Check for continuity between Rcapt, Scapt and Tcapt terminals of the inverter's Q4 thermomagnetic circuit breaker and XAC terminal strip on the electronics block, according to the following sequence of terminals (see figure):

- Rcapt – XAC.2.
- Scapt – XAC.3.
- Tcapt – XAC.4.

3. Check for continuity between the XAC terminal on the electronics block and the intake board as per the following list:

- XAC.2 – J8
- XAC.3 – J7
- XAC.4 – J6

Another task to be performed is a visual inspection of the varistors on the intake board. Check that the thermal fuse is not damaged.

The intake board varistors comprise a thermal fuse (FU) and a varistor (VA). The way to check that the varistor is operating correctly is to perform the checks listed below:

Between pins 1 and 2, you must get a high impedance reading in the kOhm range.

Between pins 2 and 3 you must get a reading of 0 ohms approximately.

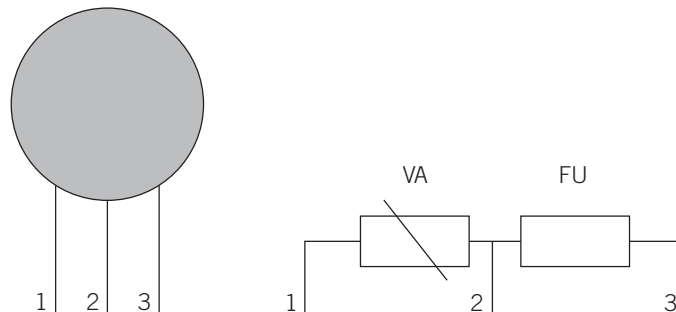

If all the above checks are correct and a 0002H alarm persists, what remains to be checked is that the impedance of each phase of the inverter output to ground is very high. To do this, remove fuses F6, F7 and F8.

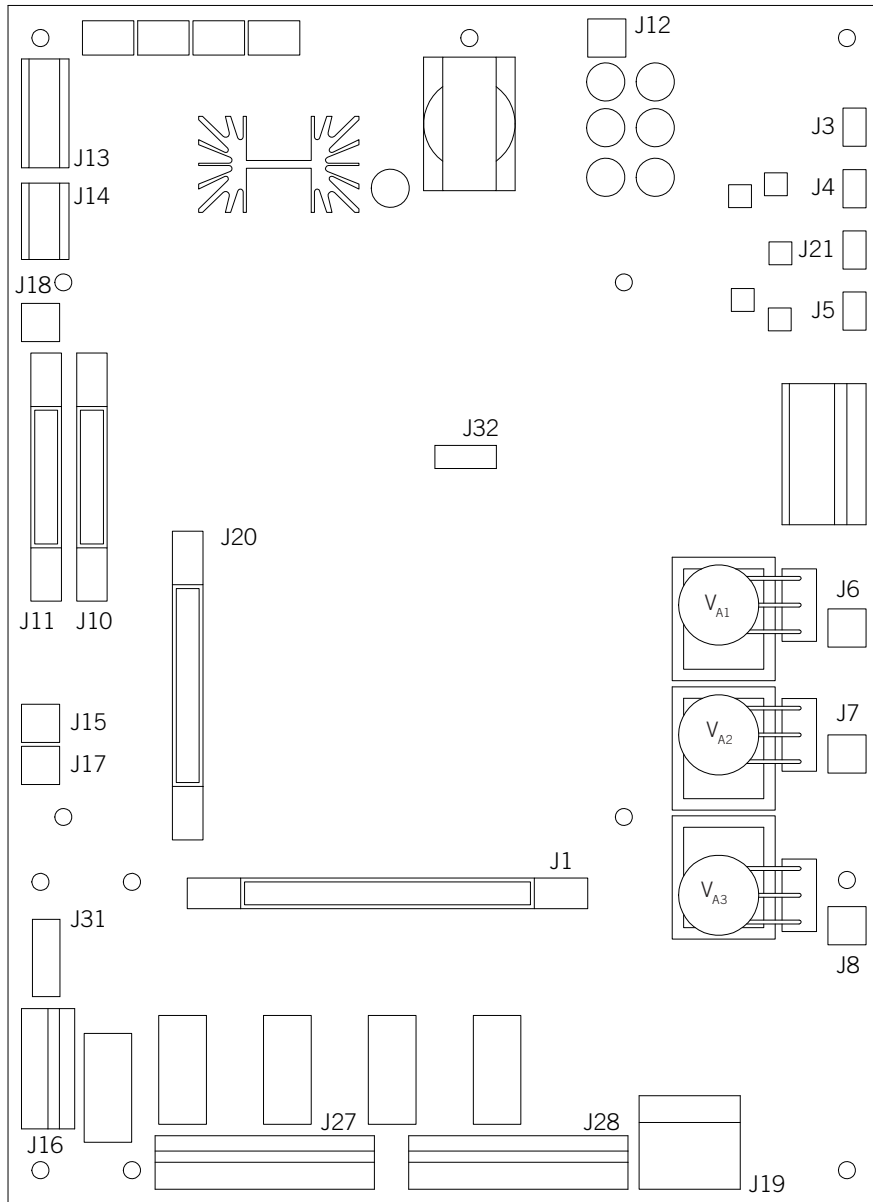

Intake board

9.4.2. Temperature

Code	Alarm	Reason for shutdown	Description
0020H	Temperature	Power electronics temperature.	The power electronics exceeds 176 °F (80 °C).
		Auxiliary temperature sensor	The auxiliary temperature sensor has triggered an alarm

In the event of a shutdown with reason “Motivo Paro Temperatura”, the first step is to check if the 0020H alarm persists. If so, check the temperature of the unit’s radiator via the display menu:

MONITORING → TempRad

- If the temperature displayed is close to or above 80 degrees, the unit has failed to inject power as a precaution against a potentially damaging radiator temperature for the unit. The inverter will remain in this state until the radiator has cooled, and then it will reconnect to the network.

If the problem occurs frequently, you should check the ventilation (fans and air intake grills) of the inverter and the enclosure in which it is installed.

- If the temperature shown is less than 140 °F (60 °C) and the alarm persists, the problem could be in the thermal switch built into the inverter in the radiator of the electronics block.
- If the displayed temperature is abnormally low (compared to room temperature), the root of the problem could be with the NTC built into the inverter.

Checking the NTC

To check the NTC of the unit you will need to access the J18 terminal of the intake board. This terminal can be found underneath the control card.

In terminal J18, do not connect wires coming into J18.1 and J18.2, and use a multimeter to measure resistance between them. The resistance measured should be approximately 5 kΩ at around 77 °F (25 °C) ambient temperature. It should be borne in mind that, since this is an NTC, for temperatures below 77 °F (25 °C), the resistance reading will be greater than 5 kΩ, whereas for temperatures above 77 °F (25 °C), the resistance reading will be lower than 5 kΩ. See below the characteristic curve of an NTC.

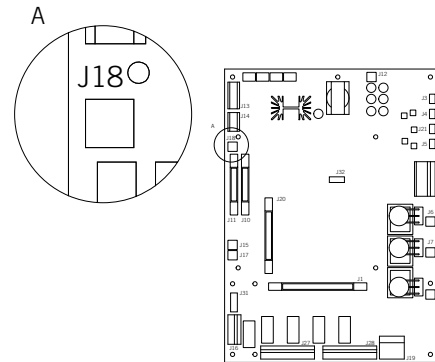

Rewire the NTC on the J18.1 and J18.2 connector and measure the resistance between the connector pins with the multimeter. The resistance measured should be approximately 1 kΩ.

In case any anomaly in the inverter’s NTC is found, contact technical support.

Checking the thermal switch

To check that the thermostatic switch is functioning properly, check for continuity between terminals X1.2 and x1.7 in the upper left corner of the electronics block. The figure represents the entire terminal strip to identify it more easily.

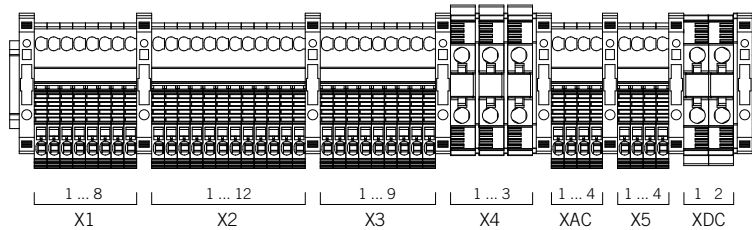

If there is continuity between X1.2 and X1.7 proceed to check continuity between J19.2 and J12.1 in the intake board.



To locate the position of the terminals within the intake board, see explanatory drawing titled “Intake board” on page 59.

If you do not have continuity, you should contact technical support.

9.4.3. AC circuit protection

Code	Alarm	Reason for shutdown	Description
0100H	AC Protection	AC Protection	Error in some of the AC protectors, arresters, fuses.

In the event of a *Motivo_Paro_Prot_AC* reason for shutdown, check the status and monitoring of the AC circuit protections of the module in question.

To check the status of the protections, perform an in-depth check of section “6. Commissioning” in this document.

If the AC circuit protection status is correct, proceed to verify their monitoring. To do this, you will need to check the monitoring branches:

AC PROTECTION

Consists of thermomagnetic circuit breakers IQ3, IQ4, IQ5 and IQ1.

AC ARRESTER.

Consists of IRV4–5.

To check the AC feed branch, you should see continuity between the ends of the monitoring circuit: IQ3 13 and IQ5 14. Then you should check that power is reaching the electronics block from X1.5. To do this, check that there is continuity between terminals X1.5 and J19.6.

If there is continuity between terminals X7.7 and X1.4 of the AC branch arrester, it is running properly.



To locate the position of the terminals within the intake board, see explanatory drawing titled “Intake board” in point 8.4.1.

9.4.4. Reason for contactor shutdown

Code	Alarm	Reason for shutdown	Description
0100H	AC protections	Reason for contactor shutdown	The state of the contactor is not correct for the current inverter status.

The “contactor” reason for shutdown is associated to alarm 0100H. This reason for shutdown requires checking the following points:

- Contactor coil wiring. There should be continuity between terminals X3.1 and X3.2. Proceed to check that the electronics block is powered. To do this, check continuity in the following points:
 - X3.1 – J16.1
 - X3.2 – J16.2
- Check continuity first between X8.1 and X3.1 and then between X3.1 and X8.2.
- Signalling status. Resistance between terminals X7.5 and X1.3 should be approximately 5.5 kΩ.

9.4.5. DC circuit protections

Code	Alarm	Reason for shutdown	Description
0200H	DC protections	DC fuses	Blown DC input fuses or DC arresters.

In the event of a “0200H” alarm, check the status of the DC fuse branch. To check for proper status observe the following:

- Continuity between terminals X7.7 y X1.1.
- Continuity between X1.1 and J19.1.

9.4.6. Insulation fault

Alarm 0400h is related to an insulation fault and can be one of two types:

- External to the unit.
- Internal to the unit.

External to the unit

To check whether the insulation fault is external to the unit, see whether the Rpv+ and Rpv- impedances are displayed on the display screen (selecting the fifth screen from the monitoring menu). Given the insulation fault, one or both will be 0 or a low figure.

Disconnect the power and open the DC isolating switch. If the Rpv+ and Rpv- impedances cease to be invalid, the fault is in the PV array. If one of them is balancing out and gives an intermediate reading, the inverter is triggering the insulation fault.

Inspect the installation.

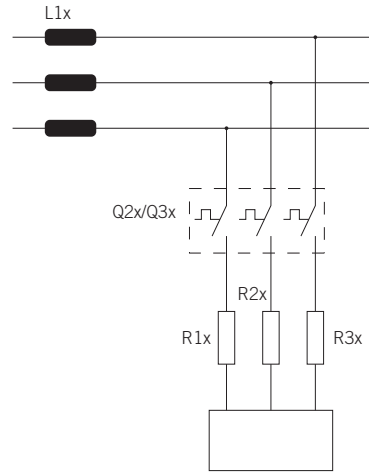

Switching harmonics filtering

Internal to the unit

If the insulation fault is caused by the unit, you must cut the DC power supply and wait 10 minutes before opening the inverter for the first time.

If the fault is not as specified earlier, it will be necessary to look for it in the DC and/or AC part of the unit.

In the DC part of the unit, you will need to check the arresters and wiring. Using a multimeter, check that the resistance and ground capacitance of each pole of the DC battery bus is the same.

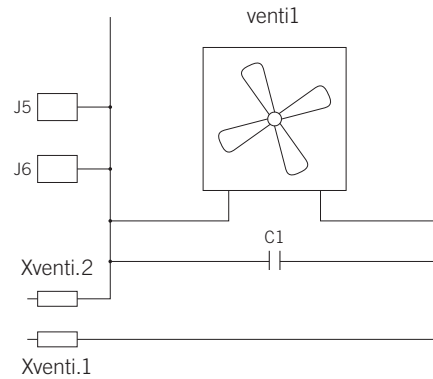

In the AC part of the inverter, check that the resistance of each of the inverter's outputs to ground are in the MΩ range. Check also that the Q3 filter or the wiring of the unit's fans aren't producing the earth fault. To do so, open Q3 to separate circuits. In the filter is causing the ground fault you will need to check the wiring. If the fans are causing the ground fault, you will need to disconnect terminals XVENT1.1 and XVENT1.2.

9.4.7. Manual shutdown

Code	Alarm	Reason for shutdown	Description
1000H	Manual shutdown	Manual shutdown	Manual shutdown with the emergency push button via display or communications.

To verify that the emergency stop button works properly, check for continuity between terminals X3.8 and J17.1, and between terminals X3.9 and J17.2.

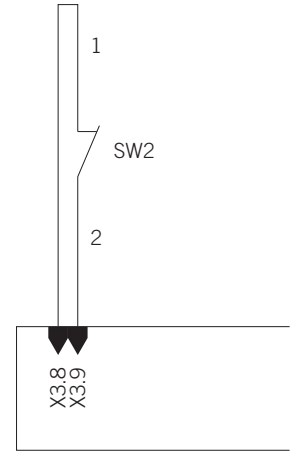

Emergency push button

9.4.8. Protection of the switching filter

Protection of the switching filter is via the Q3 thermomagnetic circuit breaker.

The Q3 thermomagnetic circuit breaker belongs to the switching filter protection. To determine the reason for shutdown of the Q3 thermomagnetic circuit breaker, follow the following procedure:

1. Check that the protection in question is turned to maximum. If not the case, calibrate it to the maximum and check operation.
2. If the problem persists, check that the capacitance of the switching harmonics filter in each of the three phases is adequate. Use a multimeter to measure the capacitance between phases and check that all have the same value. If not the case, proceed to replace the filter.
3. If after taking the 2 steps above the problem persists, take note of the unit's serial number and look at what version of firmware it has. If you do not know what version of firmware the equipment has, it will be enough to power the unit with DC and check it through display by: OK → Monitoring → Status. The status will show digit coding of the form _Letter, whereby the letter indicates the unit's firmware version. Ensure that the firmware version is letter N or later. With all this information, call Customer Service on the number on the cable protectors on the base of the unit's door.

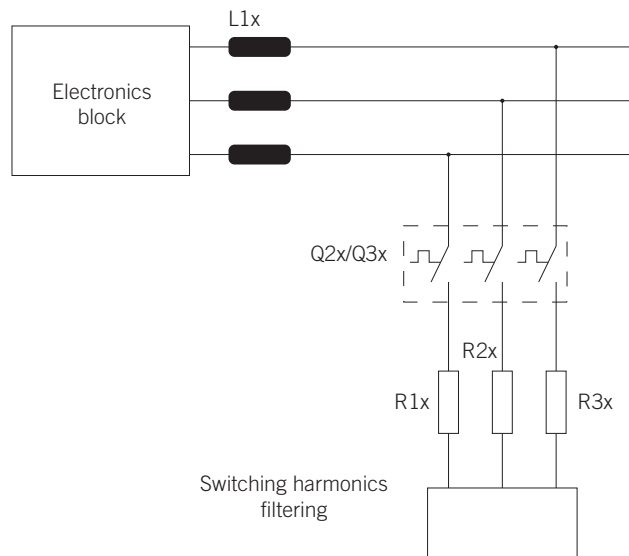

9.5. Replacing the electronics block

The unit's main electronic boards (control board, power board, IGBTs, etc.) are its core element, and they are grouped in a stainless steel cabinet known as the "electronics block".

In case of equipment damage requiring the replacement of this "electronics block", proceed as follows:



The electronics block is a heavy element. We suggest that it be carried by two people or with mechanical assistance.

When handling the block, personal protective equipment (PPE) must be worn: helmet, goggles and safety boots.

The tools needed to replace the electronics block are:

- Flat screwdriver for terminal connections.
- Ratchet and spanner 17 (M12) for AC and DC connections.

To fix the electronics block:

- Ratchet 13 (M8) for fixing the electronics block.
- Ratchet 7 (M4) for removing the top cover.

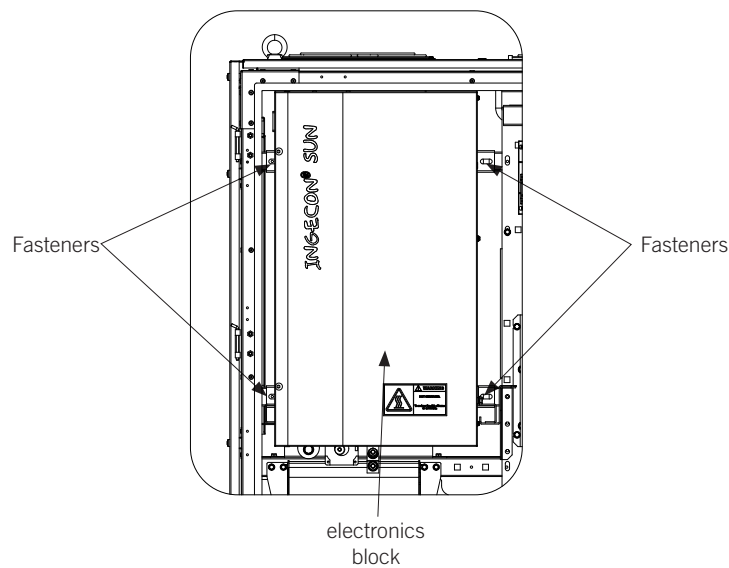

Proceed in the following order:

1. Disconnect the unit from the power grid and the PV array.
2. Wait at least 10 minutes for the capacitances to discharge.
3. Check that there are no voltages inside the unit.
4. Disconnect the "Power cables" at the bottom of the block.
5. Disconnect the wires entering the "Terminal strip" from outside the block.
6. Disconnect communication boards or analogue inputs.
7. Disconnect the display cable.
8. Unscrew the four anchor points or "fastenings".
9. Remove it.

For reassembly, perform the same steps in reverse order and then finally configure the electronics blocks:

1. Mount it
2. Tighten the fixing screws
3. Disconnect the display cable
4. Connect communication boards or analogue inputs.
5. Connect the wires entering the "Terminal strip" from outside the block.
6. Connect the "Power cables" at the bottom of the block.
7. Connecting the unit to the PV array.

9.6. Replacing varistors in the intake board

The varistor is connected to the 3-pin connector on pins 1 and 2. Pin 3 is for connecting the thermal fuse.

The varistor must be connected as follows:

- Check continuity of the fuse with the varistor outside the board using the tester.
- Place the varistor on the board in position 1-2 varistor, 2-3 fuse.

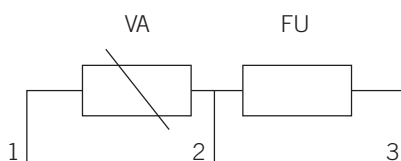
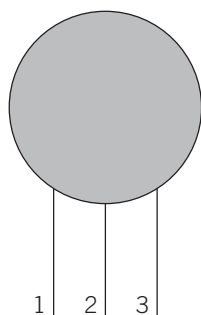
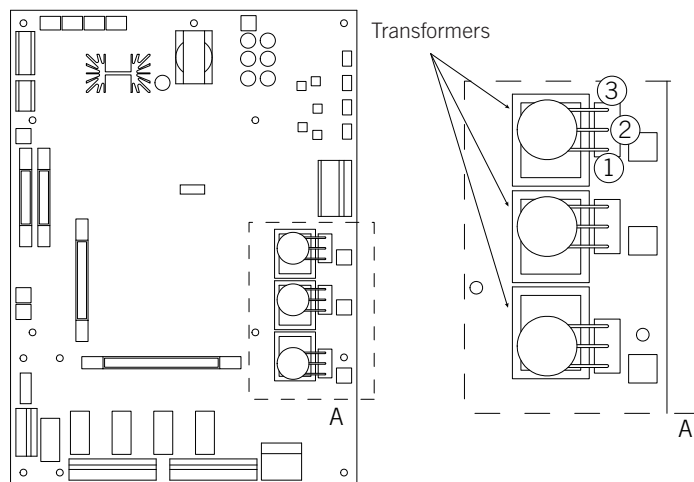

Inserting the varistor back-to-front will destroy it.

9.7. Description of terminal strips

The terminal strip is made up of type ZKS plug-in connectors and type WDU screw-in terminals.

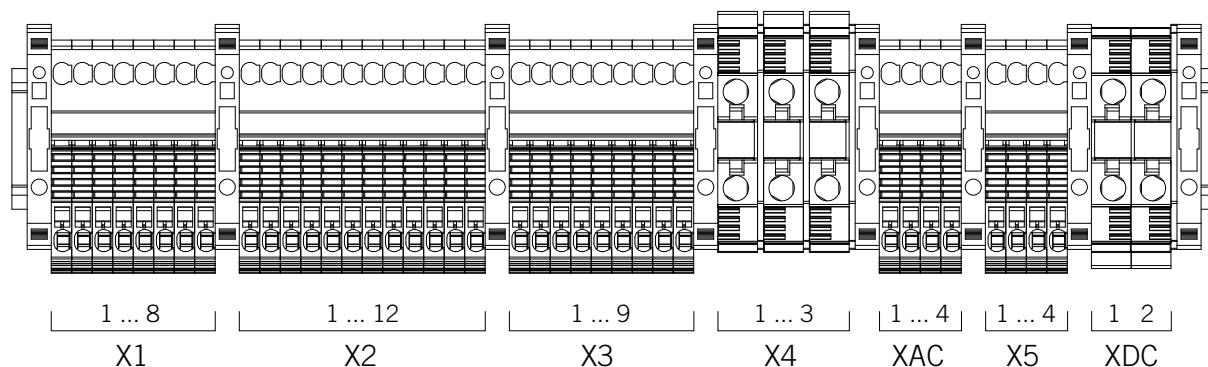

X1 Monitoring signals

X1.1	DC monitoring	X1.5	Monitoring AC thermomagnetic circuit breakers X1.6
X1.2	Thermal monitoring	X1.6	GND
X1.3	Monitoring of contact	X1.7	+15
X1.4	Monitoring of AC arresters	X1.8	+15

X3 Contactor, communications, start-stop

X3.1	Contactor coil 1	X3.8	Start-stop 1
X3.2	Contactor coil 2	X3.9	Start-stop 2

X4 Panel voltage intake

X4.1	- BUS (negative from the PV array)	X4.3	+ BUS (negative from the PV array)
X4.2	Ground		

X5 Insulation fault, grid voltage intake, fans

X5.1	NO contact insulation fault/power on	X5.3	AC fans
X5.2	NO contact insulation fault/power on	X5.4	AC fans

XDC Night-time supply connection

XDC.1	+ night SUPPLY	XDC.2	- night SUPPLY
-------	----------------	-------	----------------

AAS2000IKI04_
11/2012

Ingeteam

Ingeteam Power Technology, S.A.

Energy

Avda. Ciudad de la Innovación, 13
31621 SARRIGUREN (Navarre) - Spain
Tel: +34 948 28 80 00
Fax: +34 948 28 80 01
e-mail: solar.energy@ingeteam.com

Ingeteam S.r.l.

Via Emilia Ponente, 232
48014 CASTEL BOLOGNESE (RA) - Italy
Tel: +39 0546 651 490
Fax: +39 054 665 5391
e-mail: italia.energy@ingeteam.com

Ingeteam GmbH

DE-153762639
Herzog-Heinrich-Str. 10
80336 MÜNCHEN - Germany
Tel: +49 89 99 65 38 0
Fax: +49 89 99 65 38 99
e-mail: solar.de@ingeteam.com

Ingeteam SAS

Parc Innopole
BP 87635 - 3 rue Carmin - Le Naurouze B5
F- 31676 Toulouse Labège cedex - France
Tel: +33 (0)5 61 25 00 00
Fax: +33 (0)5 61 25 00 11
e-mail: solar.energie@ingeteam.com

Ingeteam INC.

5201 Great American Parkway, Suite 320
SANTA CLARA, CA 95054 - USA
Tel: +1 (415) 450 1869
+1 (415) 450 1870
Fax: +1 (408) 824 1327
e-mail: solar.us@ingeteam.com

Ingeteam INC.

3550 W. Canal St.
Milwaukee, WI 53208 - USA
Tel: +1 (414) 934 4100
Fax: +1 (414) 342 0736
e-mail: solar.us@ingeteam.com

Ingeteam, a.s.

Technologická 371/1
70800 OSTRAVA - PUSTKOVEC
Czech Republic
Tel: +420 59 732 6800
Fax: +420 59 732 6899
e-mail: czech@ingeteam.com

Ingeteam Shanghai, Co. Ltd.

Shanghai Trade Square, 1105
188 Si Ping Road
200086 SHANGHAI - P.R. China
Tel: +86 21 65 07 76 36
Fax: +86 21 65 07 76 38
e-mail: shanghai@ingeteam.com

Ingeteam Ltda.

Rua Luiz Carlos Brunello, 286
Chácara Sao Bento
13278-074 VALINHOS SP - Brazil
Tel: +55 19 3037 3773
Fax: +55 19 3037 3774
e-mail: brazil@ingeteam.com