

Frequency Converters

INGEDRIVE MV 900



Water Cooled Medium Voltage
4000 up to 44000 kW / 6.6 kV

Ingeteam

Frequency Converters

water cooled, medium voltage

INGEDRIVE™ MV900

The most versatile and compact solution for high power demand applications.

The INGEDRIVE™ MV900 frequency converter range has been designed for applications that require a high level of energy exchange in very demanding environmental conditions and to efficiently control energy consumption in all those sectors that require a high level of energy exchange with the least possible space and maintenance. Ingeteam has invested more than four decades of experience in the design and manufacturing of power converters, applying all its knowledge and incorporating the latest advances in control electronics, with the most reliable semiconductors and passive elements on the market. This has resulted in a family of robust, reliable frequency converters with a high power density per m³, making it one of the most compact designs available today.

Based on a modular design, INGEDRIVE™ MV900 medium-voltage converters cover a wide range of powers for the most demanding applications in sectors including mining, steelmaking, oil & gas, and the marine sector amongst others. Likewise, its versatile control architecture together with its powerful CPU (Converter Processing Unit) makes it possible to control any type of electrical rotary machine (be it induction, synchronous or permanent magnet) with the best possible performance in terms of speed and torque precision.

The INGEDRIVE™ MV900 frequency converter range extends up to 44MW and is available for an output voltage of 6600V.

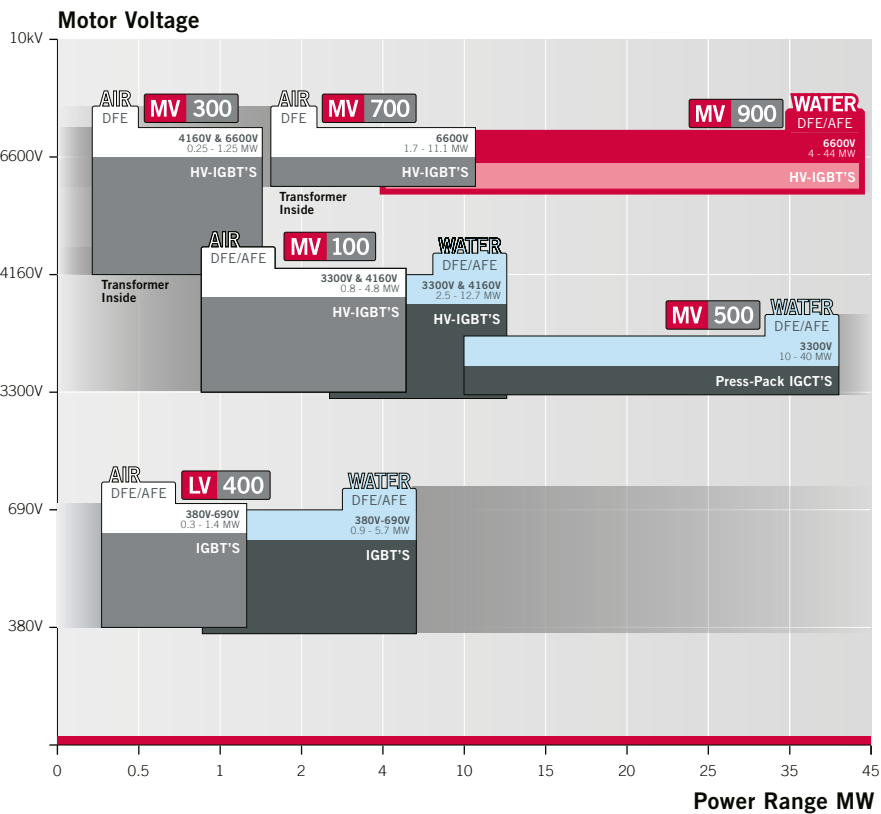

- Sectores**
- Marine & Offshore
 - Oil & Gas
 - Power Generation
 - Mining, Cement, Materials Handling
 - Steelmaking
 - Water Treatment
 - Test Benches and Wind Tunnels



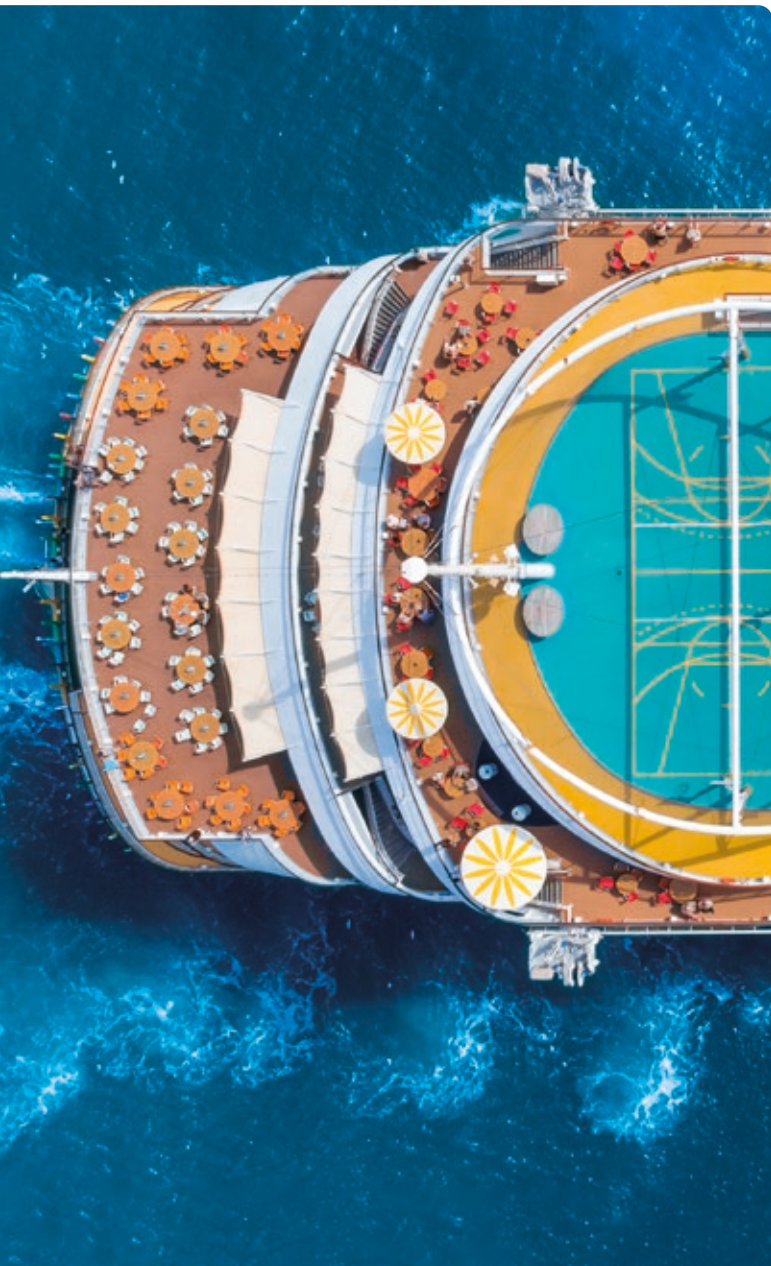

Main benefits

Robustness and integrity

The MV900 range offers different rectification configurations, and 3L-NPC inverters based on HV-IGBT power semiconductors, which make this range very robust. Available for single-drive and multi-drive topologies.

Reliable and User Friendly

Since it is designed with a minimum number of components, the 3L-NPC topology with HV-IGBTs makes it highly reliable and user friendly.

Easy Maintenance

It has been designed to minimise and facilitate maintenance and user tasks..

Highly Compatible

The INGEDRIVE™ MV900 converter is designed for installation with new or existing motors thanks to the option of including a sinusoidal filter..

Designed for highly-demanding climatic conditions

The INGEDRIVE™ MV900 family has been specially designed to work in highly demanding environmental conditions in terms of temperature and salinity.

Extensive Range

Its modular design allows it to cover a wide range of powers up to 44MW with a control capable of handling all types of motors.

Frequency Converters

water cooled, medium voltage

High-performing, robust, reliable design

It includes advanced control, protection and communications functional features.

High-quality packaging

- Front access for all user and maintenance actions.
- Protection level from IP44 to IP54.

Power management module

- Built into the power cabinet and communication with the CPU via fibre optic.

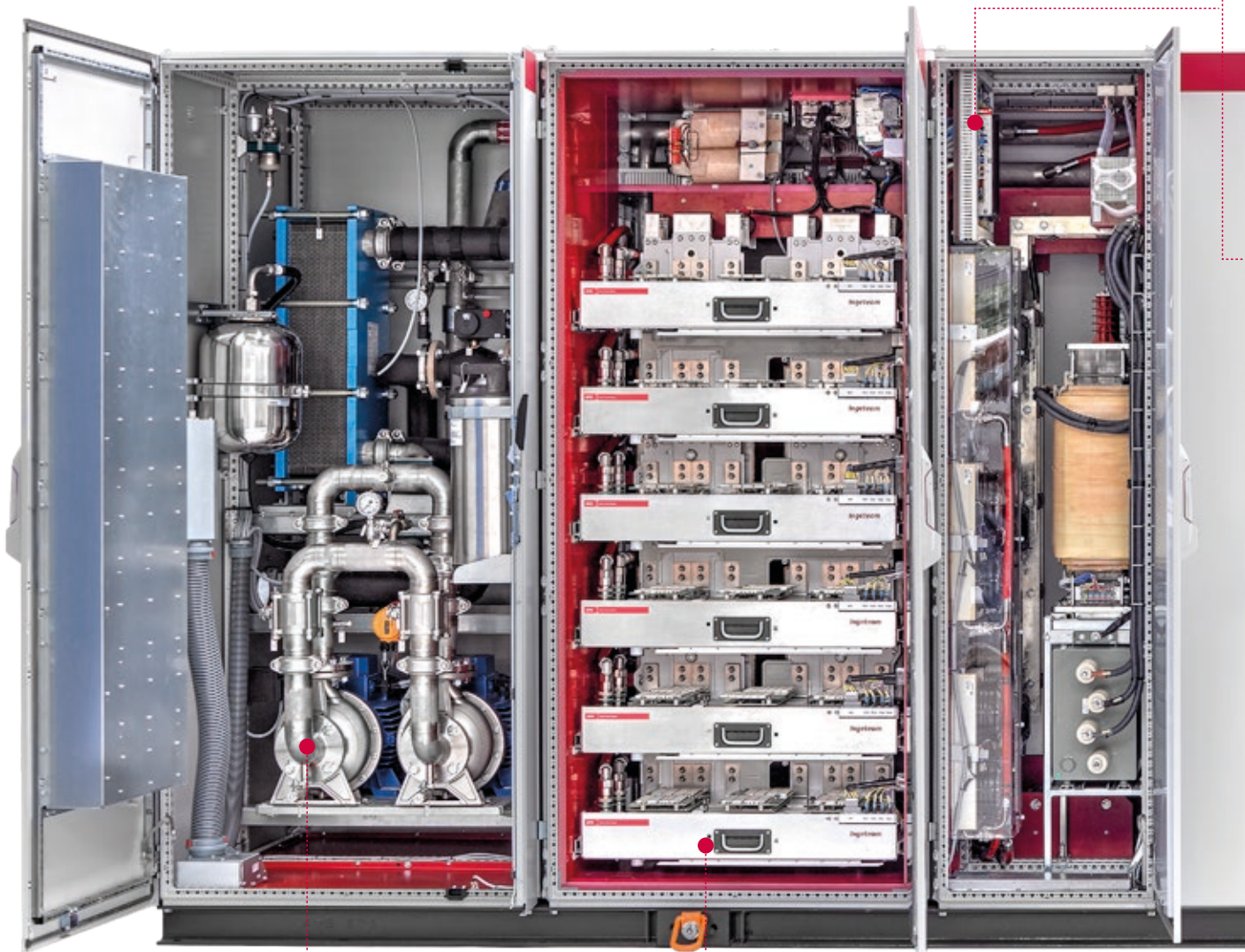

Cooling Unit

- Highly efficient design.
- Redundant refrigeration pumps
- Plate heat exchanger to isolate the primary and secondary hydraulic circuit
- Includes deionisation and conductivity measurement tanks.
- Internal air/water exchangers, to minimise air losses.

AFE-Rectifier with 3L-NPC topology based on HV-IGBT semiconductors Basic Power Modules [BPM]

- HV-IGBTs based.
- Easy access, maintenance and replacement.
- Control through fibre optics.

Inverter with 3L-NPC topology based on HV-IGBT semiconductors Basic Power Modules [BPM]

- HV-IGBTs based.
- Easy access, maintenance and replacement.
- Control through fibre optics.

Touch screen for local control [HMI]

- Powerful, user-friendly interface.
- Remote and local accessible control.

Safety

- Grounding switch and key sequence for maximum safety including door blocking.
- Emergency stop button.

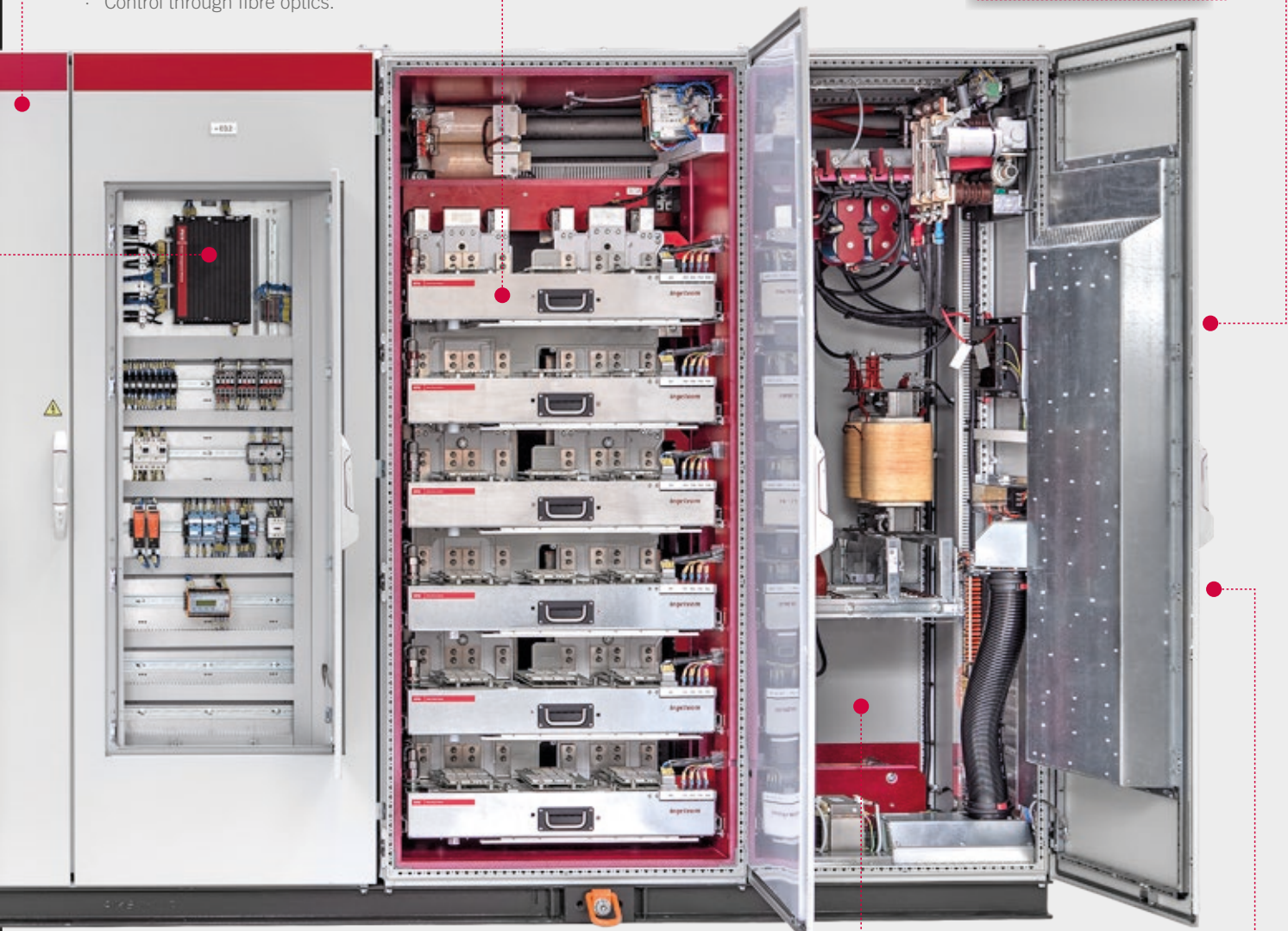
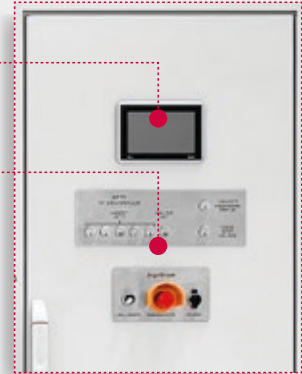

Input Cabinet

Input LRC Filter

- Standard dv-dt Filter
- Optional sine-wave input filter, which allows optimum THD values to be achieved and compliance with international grid standards.

Main Terminals

- For Control and Power Wiring
- Available with lower or upper input.

Output Cabinet

High motor compatibility

- Standard dv-dt Filter
- Optional sine-wave filter, which allows long distances between the motor and the converter or connection to an older motor.

Easy access cabinets

- For Control and Power Wiring
- Available with lower or upper input.

Control Unit

- Powerful CPU for regulation and control, with a built-in PLC for basic control logic.
- Remote diagnostics, monitoring and control via a web application without the need to install any additional software.
- Easily accessible cabinet and main components.
- Modular and scalable control topology.
- Robust, certified control design

Frequency Converters

water cooled, medium voltage

Control Features

In order to analyse the potential, architecture and adaptability of the control system offered by INGEDRIVE™ equipment, the following three areas need to be considered

HMI and Operator Panel

The whole INGEDRIVE™ family has powerful, user-friendly interface tools developed for parametrisation, commissioning, use and maintenance and for users of all levels, using the following:

- Web Application: Embedded in the CPU with functional features such as software updating, alarms log, parametrisation, with user level definition.
- Operating panel: user-friendly tool with a touch screen containing important information such as the general status, measurement, alarms and basic local control functional features.
- Remote Diagnosis, Control and Log: The whole INGEDRIVE™ family offers clients powerful tools for commissioning and support based on web technology. This server technology only requires a web browser, allowing remote access via Ethernet to all enabled functional features.
- Customized panels: Ingeteam offers a package of tools for developing and customizing the HMI: both the web application and the operating panel are easily customizable so that they can be adapted to client requirements, permitting customized development according to the client's own requirements.

Hardware Architecture

The control hardware is based on standard shared modules for the whole INGEDRIVE™ family, both in low and medium voltage. The control system consists of the following main modules: PMM [Power Management Module] and CPU [Converter Processing Unit] which permit a multi-drive configuration and can be used for different topologies.

The main characteristics are as follows:

- Reliable hardware based on standard modules
 - Versatile modular design
 - Validated in different application sectors
- Advanced processing capacity
 - DSP processor for regulation and control functions
 - PLC microprocessor for control logic functions
- Powerful interface for inputs and outputs
 - High-resolution measurements
 - Option for digital/analog input/output expansion

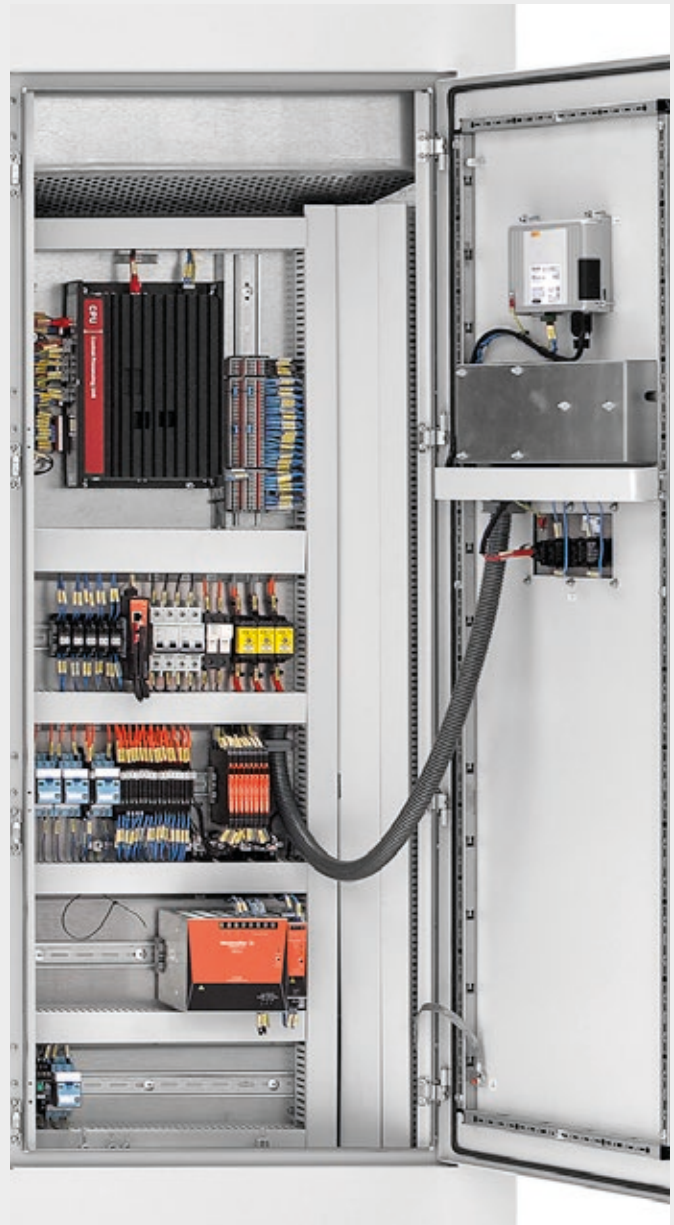

- Permits communication with multiple field buses
- High electromechanical resistance
- Robust design with metal casing
- EMC-certified (IEC 60092 / IEC 61800)

PLC and Control Software

Standard INGEDRIVE™ devices contain a PLC whose programming is based on the IEC61131-3 standard, allowing the client to use their own logic and program their own signals and communication according to their needs. The INGEDRIVE™ family's control system is so powerful and versatile that it can be adapted to the different converter topologies of the whole range, such as the following:

- Two-level inverter.
- Three-level NPC inverter with vector modulation or selective harmonic elimination.
- 5-level inverters with H-Bridge topology.

Furthermore, the control system is capable of managing not only single-drive but also multi-drive configurations, adapting itself to the requirements of different applications with the following functional features:

- Multi-drive topology adapted to the requirements of the application
- DC bus voltage regulation using DFE or AFE technology
- DC bus voltage regulation using DFE or AFE technology.
- Frequency converter for hybrid topologies: Static Frequency Converter.
- Option to control multiple types of machine with auto-tuning control algorithms developed for each type of motor.
 - Asynchronous motor.
 - Synchronous motor (brush / brushless).
 - Permanent magnet motors.
 - Vector control.
 - Encoderless vector control (sensorless).
- Battery control for hybrid topologies.
- Redundant topologies using doubly-fed motors: Synchronous and Asynchronous.

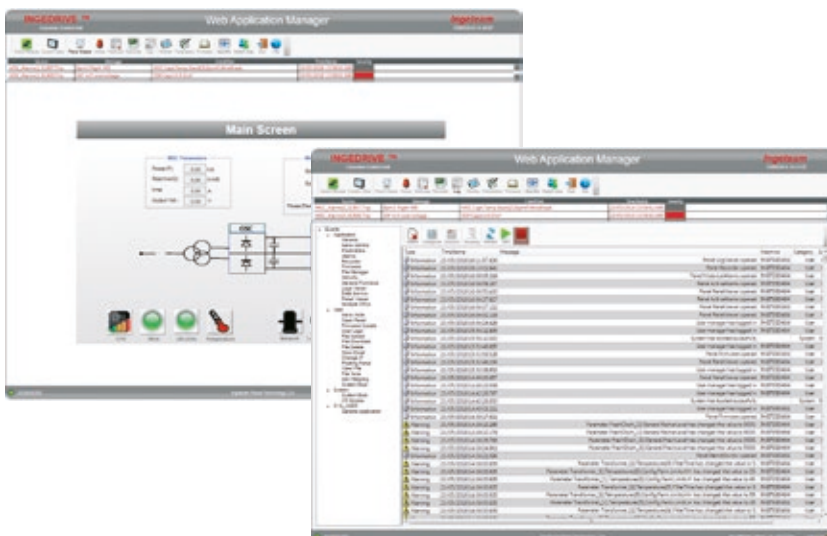

Frequency Converters

water cooled, medium voltage

Topologies

Multi-Drive Solutions:

multi-drive applications in which several inverter stages are connected to a common DC bus. When some motors brake, others can accelerate transferring energy between both via its/ their DC bus connection. (Example: Mill stands with coilers and downcoilers for the steelmaking industry).

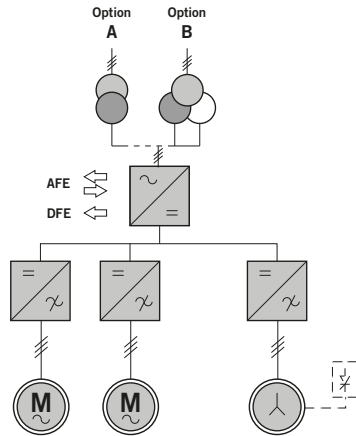

Redundant single-drive solutions:

applications consisting of motors doubly-fed by two converters whose rectifier stage can be DFE or AFE.

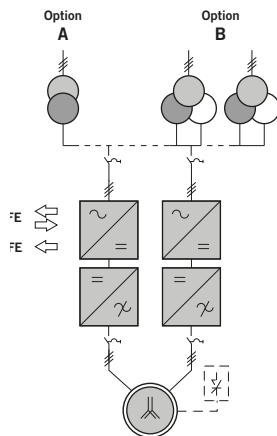

Single-Drive Solutions:

V

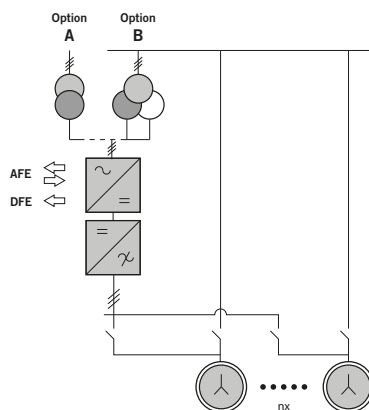

Why Ingeteam?

flexible + customized

One of Ingeteam's cornerstones and hallmarks by which our clients recognise us is our flexibility and ability to adapt our products, services and solutions which, together with the high standards of quality in our products, make INGEDRIVE™ a leading reference in the major sectors where we are present..

Flexibility: Adapting ourselves to design requirements, adapting our products to specific applications, offering flexible service and support whenever and wherever our clients need it.

Customization, taking the main element of any INGEDRIVE™ equipment which is the BPM (Basic Power Module) or power module. Ingeteam's design and engineering department adapts the final product to comply with each client's specific requirements, without compromising reliability or robustness and increasing usability and optimisation for each application.



Certifications

The MV900 series complies with the IEC standards for medium-voltage equipment as well as having certifications such as the following:

- CE marked certificates
- Marine application certification: BV, DNV-GL, LR, etc.
- Asbestos Free
- Green Passport



We not only manufacture devices but also personalise them to offer the best solution in a wide range of sectors including the marine sector, industry, mining, and oil & gas. Perhaps this is why over 90% of our clients rate us as being flexible and as providing highly-customizable solutions. These two cornerstones are complemented with demanding quality standards which all of our products are subjected to, allowing Ingeteam to offer.



More than 45 years' experience in power converters

Over 45 years' experience in power electronics for applications in a wide range of sectors including energy generation, industry, mining and the marine sector have created an extensive, solid knowledge base. This enables our design and engineering department to advise our clients on the best option and adapt equipment and software to each particular application, thus offering custom-made solutions.



Load tests of all equipment at rated current

With the aim of including the latest advances in power electronics in INGEDRIVE™ equipment, Ingeteam boasts the largest power electronics laboratory in southern Europe and one of the biggest in the world. The testing and validating facilities cover a surface area of 13.000 m2 with a capacity for testing equipment over 40MVA and with voltages up to 6.6 kV and a team of international engineers and researchers.





Manufactured 100% in Europe

Ingeteam designs and manufactures the entire INGEDRIVE™ range in its logistics and manufacturing centres in Europe. Ingeteam always works with mainly european leading brands and directly controls the entire manufacturing process to thus ensure the final quality of its products.

Hence, Ingeteam offers combined or specific tests, besides the routine tests carried out on all INGEDRIVE™ equipment.

Frequency Converters

water cooled, medium voltage

6600 V _{AC}		With dv/dt filter			With Sinusoidal filter	
Rectifier Type	Power kW	Current A	Width mm	Weight kg	Width mm	Weight kg
 DFE 24 Pulse <small>V_{IN} = 4x 1850 V_{AC}</small>	10000	1000	3810	3765	4810	6540
	18000	1800	6610	6670	8610	12200
	20000**	2000				
	27000	2700	9410	9575	12410	17900
	30000	3000	N/A	N/A		
	36000**	3600	6610	12480	8610	23580
	40000	4000	N/A	N/A	8610	23580
 AFE With external transformer (Xsc 15%) <small>V_{IN} = 6600 V_{AC}</small>	10000	1000	4610	4960	5610	7735
	18000	1800	8210	9060	10210	14610
	20000**	2000				
	27000	2700	11810	13160	14810	21485
	30000	3000	N/A	N/A		
	36000**	3600	8210	17260	10210	28360
	40000	4000	N/A	N/A	10210	28360
With external transformer (Xsc 7%) <small>V_{IN} = 6600 V_{AC}</small>	10000	1000	5610	7735	6610	10510
	18000	1800	10210	14610	12210	20160
	20000**	2000				
	27000	2700	14810	21485	17810	29810
	30000	3000	N/A	N/A		
	36000**	3600	10210	28360	12210	39460
	40000	4000	N/A	N/A	12210	39460
Transformerless <small>V_{IN} = 6600 V_{AC}</small>	10000	1000	5610	7735	6610	11510
	18000	1800	10210	15610	12210	22160
	20000**	2000				
	27000	2700	14810	22985	17810	32810
	30000	3000	N/A	N/A		
	36000**	3600	10210	30360	12210	43460
	40000	4000	N/A	N/A	12210	43460

** Double winding motor required (not applicable when using sine-wave output filter) Back: 1260mm (2520mm for 36 and 40 MW) Height: 2200mm

Considerations

Motor type: Squirrel Cage induction

Performance: 96%

Power factor: 0.91

Ambient temperature: 0 °C to 45 °C (max.). Up to 55 °C with reduction factor

Load type: Variable torque

Network voltage : Motor voltage

Altitude: < 1000 m.a.s.l. (metres above sea level) / Up to 5000 m.a.s.l. with reduction factor

MV 900

INGEDRIVE

In sectors where there is a high demand for power –such as in large pumping stations, as well as for grid applications– it is essential to have reliable, robust and low maintenance equipment such as the INGEDRIVE™ MV900.

Ingeteam

Frequency Converters

water cooled, medium voltage

Standard Characteristics	
Hardware Interface	Analog inputs: 2
	Analog outputs: 2
	Digital inputs: 9
	Digital outputs: 10
	Emergency control with wire break detection: 4
	Basic control panel: E-Stop, CPU access and local-remote switch
	Redundant Encoder (Except for sensorless control) [Encoder not supplied with the drive]
Miscellaneous	Lighting and socket in control cabinet
	Color operation touch screen (HMI) - 10"
	Three way valve (for Internal water temperature control)
	Redundant cooling pump set
	Space heaters (to avoid condensation in enclosures)
	Varnished boards
	Fixing rods and door retainers (only marine applications)
	Lifting lugs
	RAL7035 cabinet color
	IP44. IP54 with suitable MCT sealing modules
	CE Marking and green passport certification
	Halogen free and flame retardant materials
	Special tool (power stack handling fork lift)
	Road truck packing (basic wooden box)
	Redundant Deionization Tank
Electronic Components	Insulation Monitoring System (Except for transformerless connection)
	Internal Precharge and Discharge System
	Long life Polypropylene Capacitors
	Internal UPS
Functionalities	Black Out Prevention
	Fault Ride Through Capability
	Sensorless vector control
	Flying Start Functionality
Software	Programming plus Ingewebapp Remote Access. No license required
Documentation	Documentation set (2 printed + 2 digital) in English or Spanish

Optional Features		
Hardware interface	Extended hardware interface/package	Analog inputs: +2 Analog outputs: +2 Digital inputs: +10 Digital outputs: +10
	Extended emergency control circuit with wire break detection: +5	
	Emergency control with wire break + short-circuit detection	
	Synchronous transfer (IC3 I/O modules+ Voltage measurement) (Bypass contactors are excluded) (These modules will be placed external to the VFD in a cabinet supplied by others)	
	Expansion IO modules for additional connectivity	
	External heaters control and feeding (up to 300W)	
	External fans control and feeding	
	External Pt100 measurement (up to 8 channels)	
Communications	F.O.Adaptor	
	Profibus-DP, Modbus TCP, CAN Open, Modbus RTU, DeviceNet	
	Other Fieldbus Communication Protocol	
Miscellaneous	Filter for primary coolant	
	Primary sea water cooling	
	Special RAL painting	
	Reactive power compensation only for converters with AFE rectifiers	
	Special degree of protection	
	Customized cabinet indications (placed on door)	
	Vibration Dampers	
	Packing for maritime transportation	
	MCT sealing modules	
	Cooling pipes - side access	
Electrical Components	Output breaker	
	Output manual switch	
	EMI filter	
	Insulation Monitoring System (Only for transformerless connection)	
	Excitation module for synchronous motors (Ref.: MC9101-A)	
	Special auxiliary supply voltage	
	Grid side top power cable access	
	Motor side top power cable access	
	Over Voltage Limiter Unit (OVLU)	
	Dynamic Braking Chopper	
	Control top cable access	
Documentation	Additional documentation set and language	
Certification	DNV-GL, LR, BV, CCS, RINA, RRR, TL, Others	

Frequency Converters

water cooled, medium voltage

**CRS
360°**

**CUSTOMER
RELATIONSHIP
SERVICE**

INGEDRIVE™ Support

In our commitment to offering our clients complete and personalised solutions, Ingeteam offers a 360° CRS (Customer Relationship Service) with all of our product range, providing you with comprehensive consultancy, direct technical support, training and maintenance services throughout the lifetime of our products.

360° CRS is a dynamic, personalised service that covers all of stages and contact points between Ingeteam and our clients. The 360° CRS programme is supported by a professional technical team whose goal is client satisfaction and continuous improvement of products and services, always hand in hand with the latest advances and technologies in each application sector.



The following services are part of the 360° CRS programme



24/7 support included. **Direct access to design engineers and I+D**

and direct assistance with key technicians and engineers providing advice and high-quality support to our clients.

Once the warranty period has expired, Ingeteam offers its clients the option to extend out-of-hours customer support services provided by the Ingedrive technical support team by means of customized contracts to suit the needs of our clients.



25-year life cycle incl. service + spares

Ingeteam guarantees the repair service of the entire INGEDRIVE™ family for a period of 25 years as of the date of purchase of our equipment.



Remote Access

INGEDRIVE™ products are ready to be monitored remotely which enables Ingeteam's technical team to offer our clients the option to track and analyse any incident in a device remotely.



Commissioning

The commissioning of INGEDRIVE™ equipment is carried out by highly-qualified, multidisciplinary staff with experience in a wide range of sectors, to ensure your installation has best adaptation and best performance. This, together with the fact that devices leave the factory having been completely tested and verified, makes the commissioning time considerably shorter.



Spare Parts Stock

Ingeteam has designed the INGEDRIVE™ range based on the concept of power stacks. This enables us to have a permanent stock of main converter components in our logistical and manufacturing centres, reducing the supply times for immediately attending to potential emergencies to a minimum.



Repairs [Field Service]

Anytime, anywhere. The aim of INGEDRIVE™ Support is to minimise the impact of a potential stoppage or incident in our devices.



Technical Support and Engineering

Ingeteam offers its clients pre-sales technical and engineering support in order to provide assistance and advice during the initial stages and from the project definition to the commissioning of our equipment and delivery of our installations.



Training [Training Centre]

Ingeteam's team of course leaders offers comprehensive, customized theory and practical programmes to meet the training requirements of its clients.

Ingeteam has a specific area for providing theory and practical classes where we have specific material and converters with different topologies from the entire INGEDRIVE™ range. The different options can be summarised in two levels in which the subject content and depth of learning is adapted to the student and to the aim of the course.

- User Level Course:
Explains maintenance and troubleshooting Aimed at users and end users.
- Expert Level Course :
Aimed at equipment commissioning engineers. Suitable for integrators.

Ingeteam

© Ingeteam Power Technology · The technical data in this catalogue is subject to change without prior notice. PC00IPT_M101_/202010

www.ingeteam.com

ingedrive.info@ingeteam.com